

## TABLE OF CONTENTS

<b>Sr No</b>	<b>Contents</b>	<b>Page no.</b>
1.	Textiles terms and definitions	1
2.	Weaving	1
3.	Identification of parts	2
4.	Control panel	3
5.	Motions of loom	3
6.	Identification of reason of loom stop	6
7.	Weavers knot	6
8.	Fabric defects	8
9.	Loom patrolling	12
10.	Patrol controls	14
11.	Contingencies	17
12.	Instructions for Shift Change	18
13.	Operations for Water Jet Loom	20

## 1. Basic Textiles terms

- **Yarn:** A continuous strand of fibers/filament, twisted /non twisted, it is basic raw material for weaving.
- **Type of Yarns:** single yarn, double or multi fold yarn, spun yarn & filament yarn etc.
- **Yarn count:** the yarn count is a numerical expression which defines its fineness or coarseness.
- **Yarn count:**  
Indirect system: English count (Ne), Worsted Count etc.  
i.e. Higher the yarn number , finer the yarn.  
Direct System: Tex, Denier  
i.e. Higher the yarn number , Coarser the yarn.

## 2. WEAVING

- **Weaving** is a process of fabric production in which two distinct sets of yarns are interlaced at right angles to each other to form a fabric or cloth.
- The lengthwise yarns are called the warp yarn and the widthwise yarns are **called** the weft yarn.
- **Selvedge:** The length wise running edges of woven fabric are known as selvedges. It prevents unraveling of warp yarns.
- **Sequence of operations in weaving.**

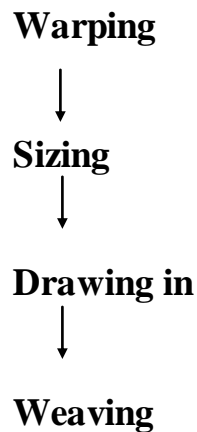

### 3 Identification of Water Jet Loom parts

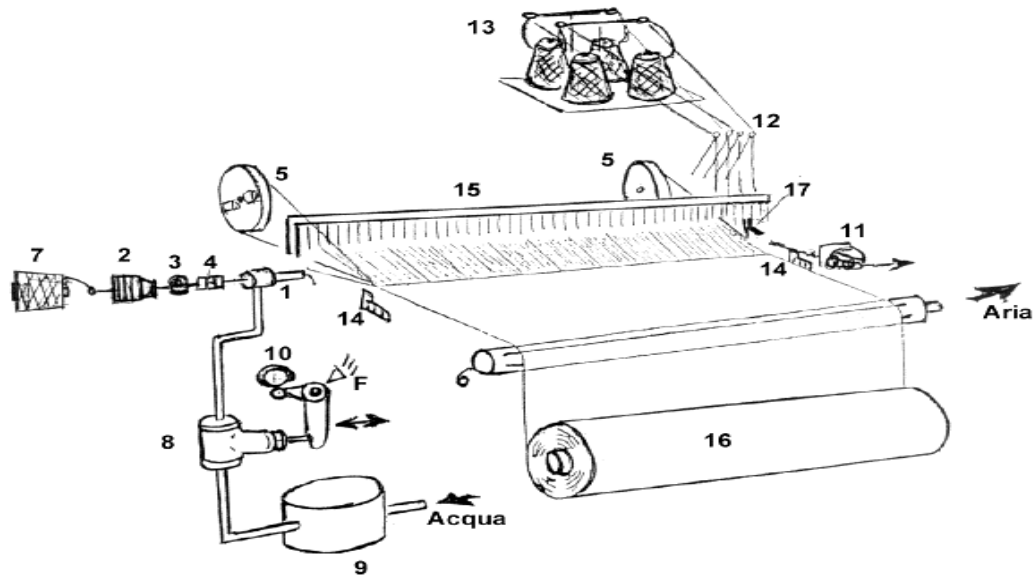

1. Main Nozzle: The water pressure is released from it.
2. Accumulator: It is the device on which reserve length of pick is wound.
3. Tension Regulator: To maintain the tension on weft (filling) yarn.
4. Weft (filling) Cramper: It is to hold the tip of the weft (filling) yarn.
5. Leno Mechanism: It is to form the selvedge.
6. Front roller: the woven fabric passes from the front roller.
7. Cone: it is a kind of weft (filling) package.
8. Pump: It is used to pressurize the water from the source to the water tank of the loom.
9. Container: Container is used for water reservoir.
10. Cam: It is required for the functioning of the pump.
11. Selvedge cones: Selvedge cones are the packages of the selvedge ends.
12. Leno head eye: it is the device through which the Leno ends pass to form Leno selvedge.

13. Clamping Device: the selvedge ends are passes through it.

14. Thermal device:

15. Heald frames: the warp ends passes through the heald eyes mounted on the heald shaft for lifting during shedding.

16. Cloth roll: It is the woven fabric roll.

#### 4. Control panel:

It is display panel provided on the machine to function various operations to perform and control such as; design loading, lifting of heald frames, jacquard and dobby operation,



#### 5. Motions of loom

##### Primary motions

##### ➤ Shedding motion

Shedding separates the warp threads normally into two layers for the insertion of a pick. The function of shedding mechanism is to raise and lower the heald frames (harness frames / shafts), which carry a group of, warp ends drawn.

There are three kinds of shedding mechanism namely **tappet, dobby & jacquard.**]

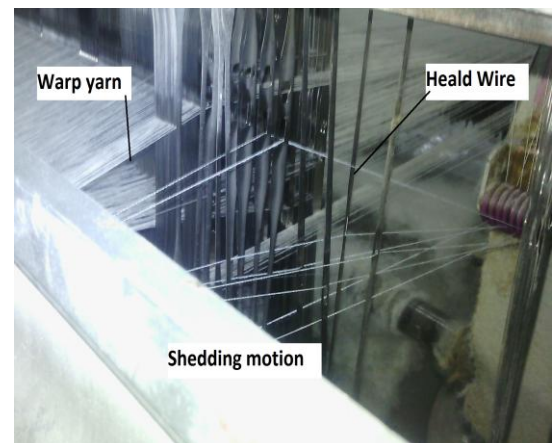

➤ **Picking motion**

- Picking motion inserts a pick (weft (filling)) from one side to the other side.
- In **Water jet** looms, pick is inserted with the help of Water pressure through the shed opened by the shedding mechanism i.e. between the two layers of warp sheet.

➤ **Beat up motion**

The function of beat up mechanism is to push the weft (filling) thread that has been inserted across the warp threads in a shed, up to the fell of cloth.

Fell of cloth is the position of the last pick in the cloth woven on the loom.

The beating-up of the weft (filling) to the fell of cloth is carried out by the reed.

**Secondary motions**

➤ **Take-up motion**

- Take-up motion pulls/winds the fabric from the area at a constant rate that is determined the required pick density.
- In water jet loom take-up motion is driven by high precision servomotors equipped with speed reducer, connected with the loom.

➤ **Let-off motion**

Let-off (warp control) controls the amounts of warp delivered and maintain the regional tension of the warp during weaving.

Let off motion is driven by high precision servomotors equipped with speed reducer, connected with the loom.

The tension on warp beam is maintained by machine automatically with the help of load cell to control the let off speed of back rest roller.

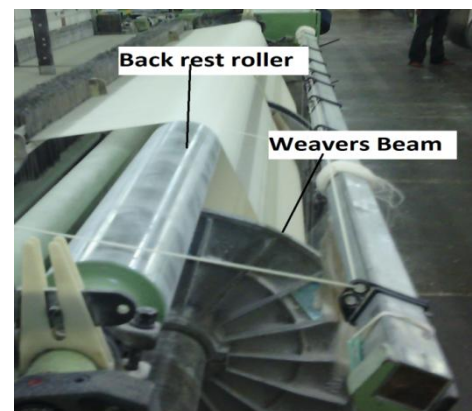

## Auxiliary motions

### ➤ Warp stop motion

Warp stop motion detect warp (end) breaks and stop the loom preventing missing end in the cloth.

There are two types of warp stop motions in use i.e. Mechanical & electrical / electronic.

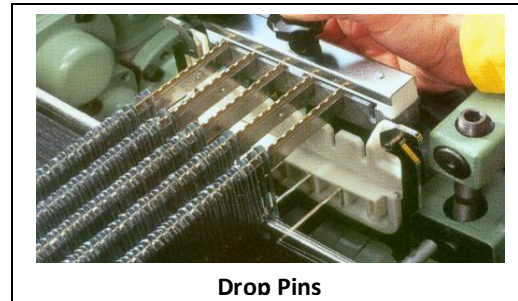

Each & every warp ends are drawn through an independent **drop pin**, which are suspended, on the yarn.

As soon as end breaks, because of the gravity, the drop pin falls on the rail between toothed portion and the movement of the rail is arrested and activates the mechanism to stop the loom.

### ➤ Weft (filling) stop motion

Weft (filling) stop motion detects weft (filling) breaks / missing picks and stops the loom to avoid crack in the cloth.

In Water jet loom optical sensor is used to control the correct weft (filling) insertion into the shed, has the task of stopping the machine in case of incorrect insertion.

The sensor is placed on the shaped reed at the desired height in the zone of weft (filling) arrival

### ➤ Pick finding motion

This motion stops the loom in the exact shed where the pick is not inserted or broken. Weaver can repair the broken weft (filling) and start the loom without causing a thick/thin place/double pick.

### ➤ Anti-crack motion

This motion prevents cracks & starting marks on the fabric, whenever there is a weft (filling) break. Fell of the cloth goes back by 1- 2 picks, which prevents a thin place.

➤ **Brake mechanism**

This motion stops the loom instantaneously as and when there is an indication of warp or weft (filling) break by warp/weft (filling) stop motion.

**6 Identification of reason of loom stop**





Stopping of loom is identified by the signal lights, which need to be understood by the operator.





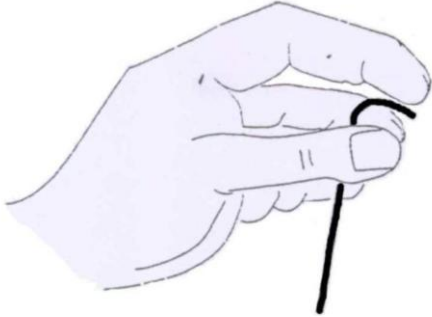

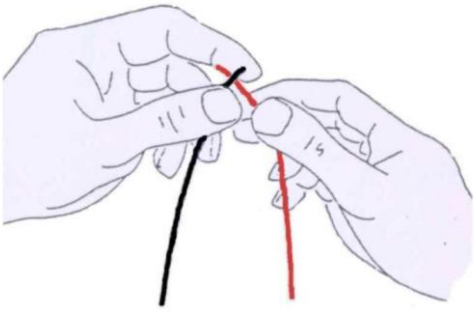
Different types of light indicators for breaks

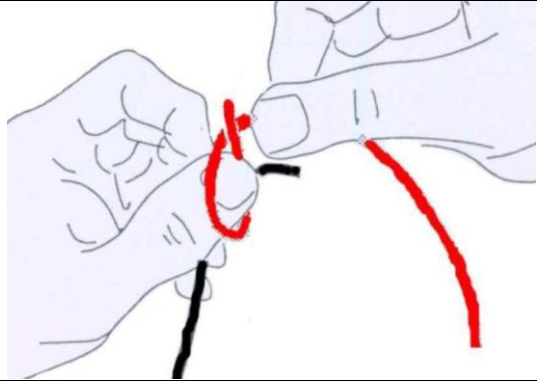

**7 weavers knot**

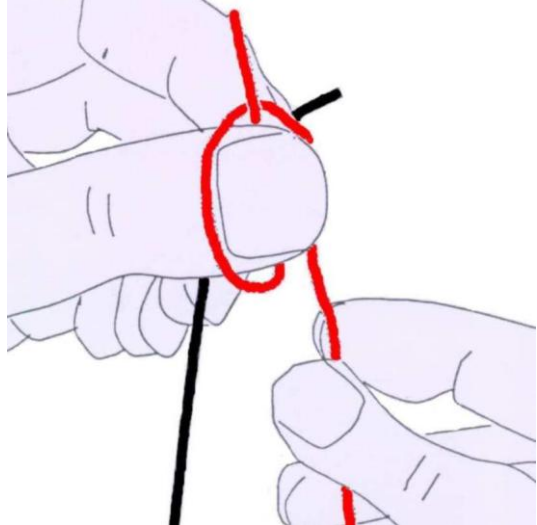
The following illustration explains the procedure for putting weavers knot.

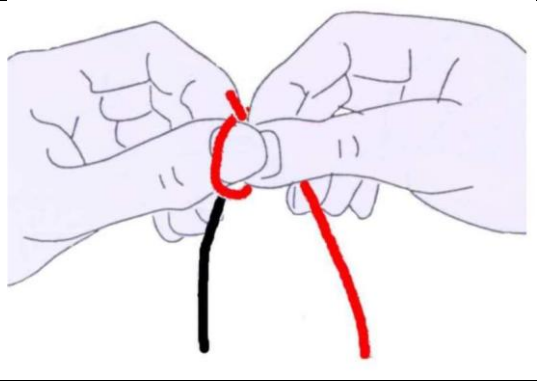
1.		
<p><b>Pick up the broken end 6 mm from its end with the left hand thumb and second (middle) finger.</b></p>		
2.		
<p><b>Then tie thread is then placed under the broken end by the right hand.</b></p>		

3.		
<p>A loop is made with the tie thread around the left hand thumb, and tie thread passed behind the tie thread end.</p>		
4.		
<p>The first finger of the left hand is moved down against the thumb to hold the loop in position on the thumb.</p>		
5.		
<p>Right hand thumb is used to push the tail formed by the broken end, under the left hand thumb.</p>		



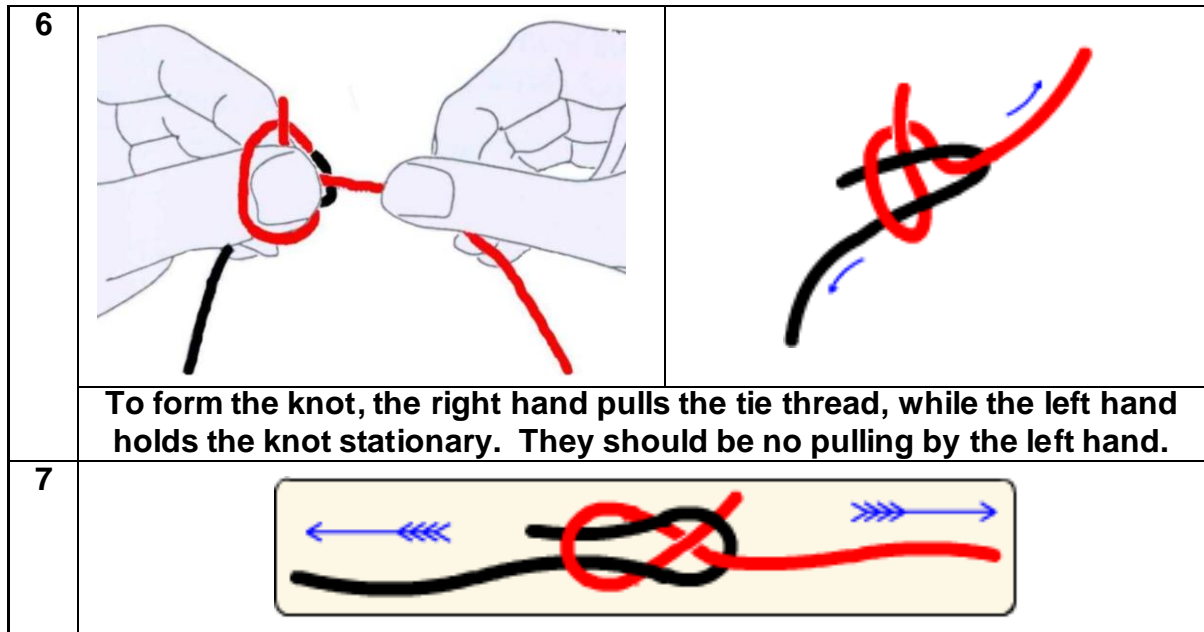

### 8. Fabric defects

Defect is an unwanted structure on the fabric due to many reasons. The following are the some of the type of the fabric defects e.g. missing ends, missing picks, reed mark, double end, weft (filling) crack, weft (filling) bar, temple mark, starting mark, float, slubs etc.

Some of fabric defect photos are:

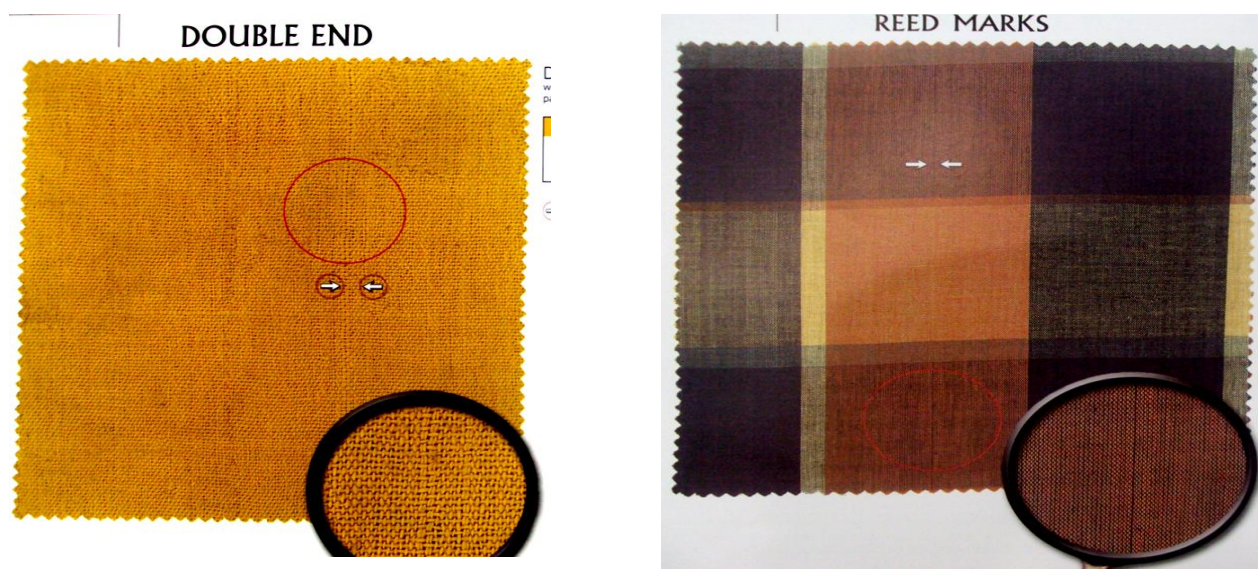

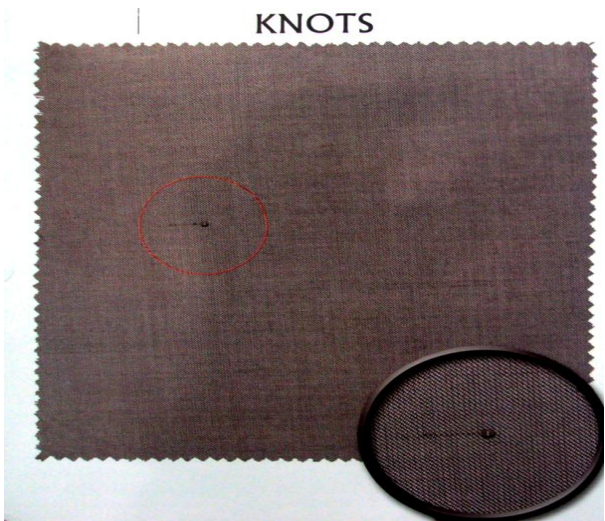
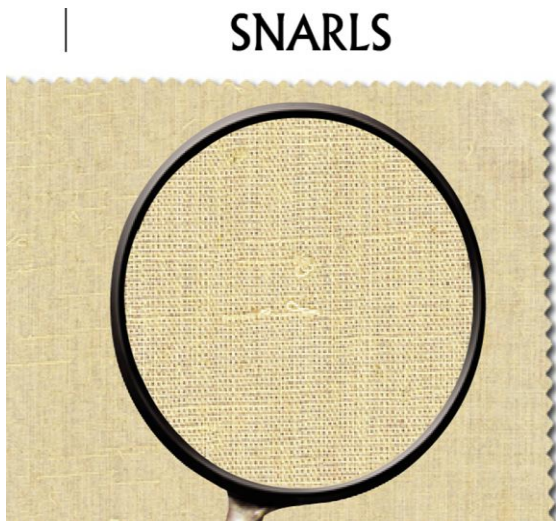
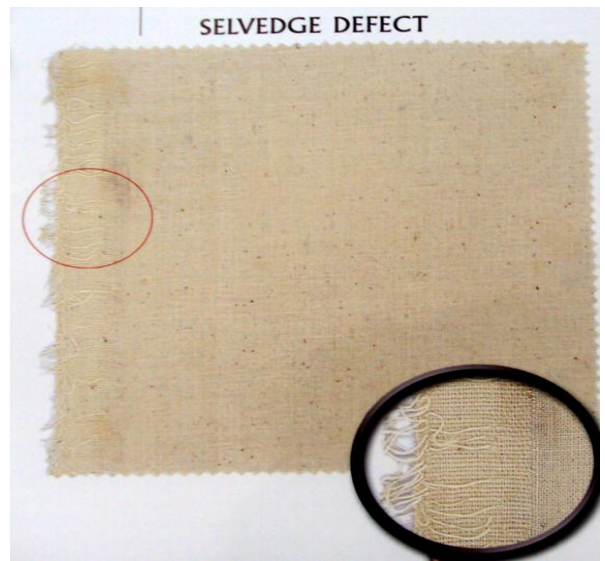

## 9. Fabric defects

**Defect table**

<b>Name</b>	<b>Appearance</b>	<b>Cause</b>	<b>Action</b>	<b>Prevention</b>
Thick place in warp direction.	Bars of denser woven fabric across cloth	Faulty let-off or take-up motion.	Inform fixer.	Constant patrol and cloth inspection.
Weaving without weft (filling).	Strings of warp yarn only.	1. Faulty weft (filling) sensor 2. Electrical fault	Inform fixer.	Constant patrol and cloth inspection.
Slack end.	A warp end gathering in the cloth.	1. End run out on the warp beam. 2. End not in drop wire.	1. Repair broken end. 2. Draw end into drop pin.	Constant patrol and cloth inspection.
End out.	Thin gap in warp	1. Warp stop motion not working. 2. Electrical fault. 3. Fluff build up in drop wires.	Inform fixer.	Constant patrol and cloth inspection
Floating end.	Un-woven warp end	1. End not drawn into heald. 2. Broken heald.	1. Draw end into heald. 2. Replace broken heald.	Constant patrol and cloth inspection
Starting mark	Light gap weft (filling) way in the cloth	1. Incorrect machine setting. 2. Not shed levelling when machine stopped	1. Inform fixer. 2. Inform fixer.	Constant patrol and cloth inspection.
Slubs.	Thick lumps of yarn weft (filling) way	1. Faulty weft (filling) yarn. 2. Not removing broken weft (filling) correctly.	1. Change cone; inform supervisor. 2. Correct weft (filling) repair .	Constant patrol and cloth inspection. Good methods.
Wrong dent.	Faint thin line warp way in the cloth.	End or ends drawn into the wrong dent.	Re-draw ends in correct dent.	Know correct denting order.
Wrong draft.	Irregular pattern warp way in the cloth.	End or ends drawn into the wrong heald.	Re-draw ends in correct heald.	Know correct drafting order.

Broken pick.	Visible line weft (filling) way in the cloth.	<ol style="list-style-type: none"> <li>1. Broken weft (filling) not completely removed.</li> <li>2. Loose pick not found.</li> <li>3. Faulty weft (filling) detector.</li> </ol>	<ol style="list-style-type: none"> <li>1. Check full width of cloth at a weft (filling) break repair water.</li> <li>2. Always check for the loose pick.</li> <li>3. Inform fixer.</li> </ol>	Always use correct weft (filling) repair water methods. Constant patrol and cloth inspection.
Thin place	Light bar across the cloth due to low weft (filling) density.	<ol style="list-style-type: none"> <li>1. Faulty let-off or take-up motion.</li> <li>2. Cloth wrapped around rollers.</li> <li>3. Faulty weft (filling) yarn.</li> </ol>	Inform fixer.	Constant patrol and cloth inspection.
Double pick.	Thick line running across the cloth.	<ol style="list-style-type: none"> <li>1. Not having found the loosing pick.</li> <li>2. Reserve cone caught and running in.</li> </ol>	<ol style="list-style-type: none"> <li>1. Always find the pick correctly.</li> </ol>	Correct weft (filling) repwater methods. Correct weft (filling) creeling method.
Thick place.	Thick bar in weft (filling) way	<ol style="list-style-type: none"> <li>1. Double weft (filling) running in.</li> <li>2. Thick/wrong weft (filling) yarn.</li> <li>3. Double weft (filling) from winding department.</li> </ol>	<ol style="list-style-type: none"> <li>1. Break the second yarn and secure correctly.</li> <li>2. Remove cone inform supervisor.</li> <li>3. Remove cone inform supervisor.</li> </ol>	Correct weft (filling) creeling method.
Warp way stitching	Unwoven ends warp way in the cloth.	<ol style="list-style-type: none"> <li>1. Fluff or knot behind the reed.</li> <li>2. Spare end weaving in.</li> <li>3. Not removing broken warp end from shed.</li> <li>4. Too long tails on weaver' knot.</li> </ol>	<ol style="list-style-type: none"> <li>1. Check and clear fluff or knot from behind reed.</li> <li>2. Remove spare end.</li> <li>3. Remove waste yarn from shed.</li> <li>4. Keep tails to 6 mm on weaver's knot</li> </ol>	Constant patrol and cloth inspection.  Correct methods for weaver's knot and warp break repwater.



Tuck in fault/long tails.	Fringe of tails close to or on the selvedge.	<ol style="list-style-type: none"> <li>1. Fluff under weft (filling) brake.</li> <li>2. Fluff under weft (filling) gripper.</li> <li>3. Leno ends drawn incorrectly.</li> <li>4. Weft (filling) threading incorrect.</li> <li>5. Weft (filling) cutter not working.</li> <li>6. Incorrect machine settings.</li> </ol>	<ol style="list-style-type: none"> <li>1. Clear fluff.</li> <li>2. Clear fluff.</li> <li>3. Correct leno end drawing.</li> <li>4. Re-thread weft (filling) correctly.</li> <li>5. Inform fixer.</li> <li>6. Inform fixer.</li> </ol>	
---------------------------	--	--	--	--

### Remedial measures for controlling the defects

Defects can be reduced by using good quality of yarn, good weaving preparations; proper loom settings at various stages of fabric manufacturing & continuous loom patrolling.

## 10. Loom patrolling

### Cycle patrolling

1. It consists of starting at a given machine and proceeding around the whole set in a regular and consistent manner.
2. The purpose of this is to inspect and correct everything that would cause a stop of the machine, before it happens.
3. This way of patrolling is especially used for high quality fabrics, or for high warp breaks, for looms without stop signalling, or for high number of looms in a section.

### Interrupted patrolling

1. This is the style of patrolling appropriate to the factory where a weaver is attending more number of looms.

2. The principle purpose is to inspect the warp side of the machine twice as often as the cloth side on a routine regular basis, the weaver only being interrupted by stopped machines. Even then, the weaver checks the intermediate machines on his way to the stopped machine.
3. In the sketch the weaver makes the following control:

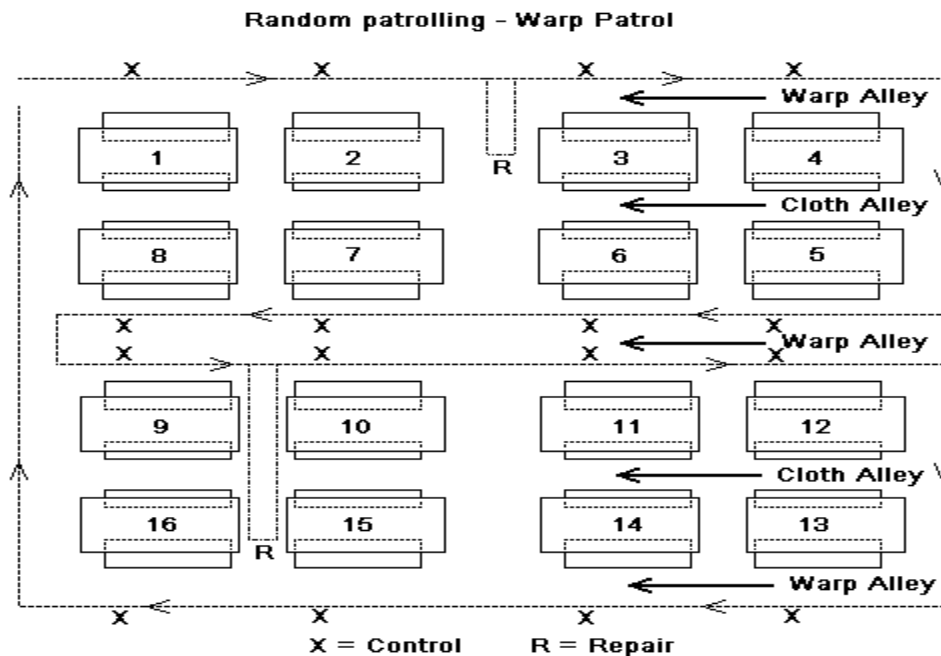

4. Assume that initially all the machines are running. Starting at the top left hand corner, the weaver is patrolling along the warp alley when the second machine along stops. In moving to that machine the weaver controls number 1 machine, which he has to pass on the way.
5. After repairing number two machines the weaver continues on his patrol inspecting the rear of machines 3 & 4 before noticing that machine 6 has stopped.
6. He therefore inspects the rear of machine 5 before walking to repair machine 6.
7. He then returns to his patrol, continuing the inspection of the warp side of the machines.
8. When he has completed round on warp side he patrols cloth side and then again warp side as indicated in the diagram. After completing two rounds on warp side

he takes one round on cloth side of loom no.4 to 1. Thus, weaver makes two rounds on warp side and one round on cloth side.

## **11. Patrol controls**

### **Back of loom (warp alley)**

**1. Slubs:**

A thick place in the warp: slubs in the warp yarn sheet can cause problems when passing through the drop wires, heald wires or reed. Once spotted it is the weaver's responsibility to remove it, to avoid warp breaks if the slub does not pass the reed; or to avoid a fault if the slub goes into the cloth.

**2. Extra end:**

Guide it through the guide eyes to the winding device.

**3. Missing end:**

Take the nearest positioned extra end and guide it through the guide eyes to the missing end position.

**4. Crossed end:**

To be corrected by the weaver.

**5. Lap end on warp beam:**

It can be an extra end coming up, or a previously missing end coming back.

**6. Thick end or wrong yarn count (ne):**

Take out, guide to the winding device, identify the end as incorrect with a label, and replace with a normal end from the extra end reserve.

**7. Stuck ends / sizing fault:**

Separate the ends with the help of the guides.

**8. Spare end bobbin:**

The extra ends provided on the warp beam need to be guided through the guides provided on the spare end bar, to the side of the loom and then wound onto the spare end bobbin. These need to be kept tidy otherwise a tangled mess will quickly result. When the bobbin is full it needs to be stripped.

**9. Fluff and fly:**

When pieces of fluff or fly have settled on the warp they should be removed immediately to prevent them from being woven in. Fluff and fly attached to machinery should be removed before it becomes detached and also weavers into the cloth.

**10. Waste / wild yarn:**

Extra piece of yarn, which have either been left on a beam or have dropped onto a loom, remove them immediately before they become entangled or woven in.

**Front of loom (cloth alley)**

**1. Cloth quality**

**a) Short picks:**

Is the weft (filling) being inserted properly?

**b) Kinks and snarls:**

Is the weft (filling) too lively or not enough tension?

**c) Weft (filling) bars:**

Is this a variation of weft (filling); or take-up or left-off motion malfunction?

**d) Uneven yarn:**

Has the weft (filling) quality deteriorated and the cone needs to be changed?

**e) Broken pick:**

Has the weft (filling) been inserted for the whole width of the cloth, either breaking in its insertion or not being held at the receiving side?

**f) Stitching:**

This is usually associated with a slack warp end, or too low warp tension.

**g) Double end:**

Two ends weaving as one in the same heald break out the extra end.

**h) Wrong draft:**

An end or ends have been inserted into the wrong heald eye, resulting in a break in the cloth pattern.

**i) Wrong dent:**

An end has been drawn incorrectly in the reed resulting in a warp line down the cloth or a break in the cloth pattern.



## 2. Selvedge

Is the selvedge complete and correct, resulting in a correct edge to the fabric?  
Are the cut-off selvedges being removed correctly? Is the selvedge construction correct?

## 3. Weft (filling) creel

### a) Weft (filling) creel cleanliness.

Make sure that there is no fluff or fly waiting to be caught by the weft (filling).

### b) Weft (filling) cone mounting/alignment:

Are the cones correctly mounted and aligned to the accumulator?

### c) Weft (filling) cone transfer tails:

Have the tails been tied correctly and the knots placed under the transfer clamps. Are the tails of the reserve cones safely fastened away from the running packages?

### d) Cones:

Are there any empty cones to replace?

## 4. Leno

Are the bobbins rotating correctly?

a) Is there an adequate supply of yarn on the bobbins?

b) Is the leno yarn being guided correctly?

c) Is the leno edge being properly formed?

## 5. Yarn guides

Are all the catch cord yarn guides clean and in good condition?

## 6. Oil

Are there any oil marks on the cloth and what has caused them? What need to be done to prevent the problem?

## 7. Temple marks

Is the cloth passing correctly over the temples? Are any marks being created?

## 8. Reed marks

Is there any warp way lines caused by a damaged reed?

## 9. Noises

Are there any unusual noises, which the fixer needs to investigate?

## 10. Vibration

Are there any unusual vibrations that the fixer needs to investigate?

## 12. Contingencies

### Warp related:

1. **Extra end:** guide it through the spring to the winding device.
2. **Missing end:** take the nearest positioned extra end and guide it through the spring into the missing end position.
3. **Crossed end:** to be corrected by the weaver during his patrol.
4. **Lap end on warp beam:** it can be an extra end coming up, or a previously missing end coming back.
5. **Thick end:** take out, guide to the winding device and replace by a normal end from the reserve.
6. **Stuck ends (sizing fault):** separate ends, with the help of the guide spring.
7. **Slub (thick place in the yarn):** once spotted it is the weavers responsibility to remove it, to avoid warp breaks (if the slub does not pass the reed), or to avoid a fault (if the slub goes into the cloth).
8. **Warp beam cleanliness:** dust and extra ends on the warp beam cause warp breaks. The weaver has to keep the beam clean.
9. **Drop wires:** when drop wires are missing or broken they must be replaced. Do not take more than one end through a wire, because the stop motion will no longer work. If there are extra drop wires, take them out or tie them up to avoid false stops.
10. **Heald change:** when a heald breaks the weaver has to change it. If there are several healds to change the weaver should call the fixer in order to avoid stopping his patrolling for a long time.
11. **Wrong draw in the reed:** the weaver must correct it immediately.

**Weft (filling) related:**

**Weft (filling) variation between cones:** when weft (filling) mixing small variations between cones is hidden. However, if a particular thick or thin yarn is introduced, an irregular appearance will result. The offending cone needs to be replaced and the supervisor informed.

**General:**

**Waste/wild yarn:** extra pieces of yarn that have either been left or dropped onto the warp. Remove them immediately before they become woven in. When trimming knots never drop the cut-off ends onto the warp.

**13. Instructions for Shift Change**

➤ **Take Charge of the Shift**

- come at least 10 - 15 minutes earlier to the work spot
- Bring the necessary operational tools like "weavers' hook", "weft wire" " knife" etc.
- should meet the previous shift weaver , discuss with him/ her regarding the issues faced by them with respect to the quality or production or spare or safety or any other specific instruction etc
- understand the type of fabric produced, specifications of fabrics, followed in the water loom for his allocated number of looms or machines
- ensure the technical details are mentioned in the display board in the waterjet loom machine
- should check for the availability of the weft cones & check the condition of the same
- check the condition of the running beams , for cross ends, ends pulling out particularly at the selvages, catch card etc
- check the availability of the " thrums" , quality & condition of the same
- check the cloth for the running damages like end out, wrong drawing, wrong denting, double end, reed mark, temple cut/ temple mark let- off mark, take up fault, oil stain, hole, cloth torn, under tuck in , tails. etc

- check for the size of the cloth rolls & to see whether any indication is there in the cloth rolls
- check whether any spare/raw material/ tool / fabric/ any other material is thrown under the machines or in the other work areas.
- question the previous shift weaver for any deviation in the above and should bring the same to the knowledge of his/ her shift superior as well that of the previous shift as well.
- ensure proper functioning of waterjet loom machine parts and machine
- ensure the wastes collection boxes are empty while taking charge of shift
- check the cleanliness of the machines & other work areas
- ensure the work spot is clean

➤ **Handing over the Shift**

- hand over the shift to the incoming Waterjet loom weaver in a proper manner
- ensure in providing the details regarding count produced, colour coding followed in the Water jet loom for his allocated number of looms or machines
- provide all relevant information regarding the type of fabric production, damaged machine parts if any
- get clearance from the incoming counterpart before leaving the work spot
- should report to his/ her shift superiors as well as that of the incoming shift operator in case his/ her counterpart doesn't report for the incoming shift
- ensure the shift is properly handed over to the incoming shift operator
- report to his/ her shift superior about the quality / production / safety issues/ any other issue faced in his/ her shift and should leave the department only after getting concurrence for the same from his/ her superiors
- collect the waste from waste collection bags, weigh them and transport to storage area
- ensure the work spot is clean

## 14. Operations for Water Jet Loom

### ➤ Attending to Warp Break

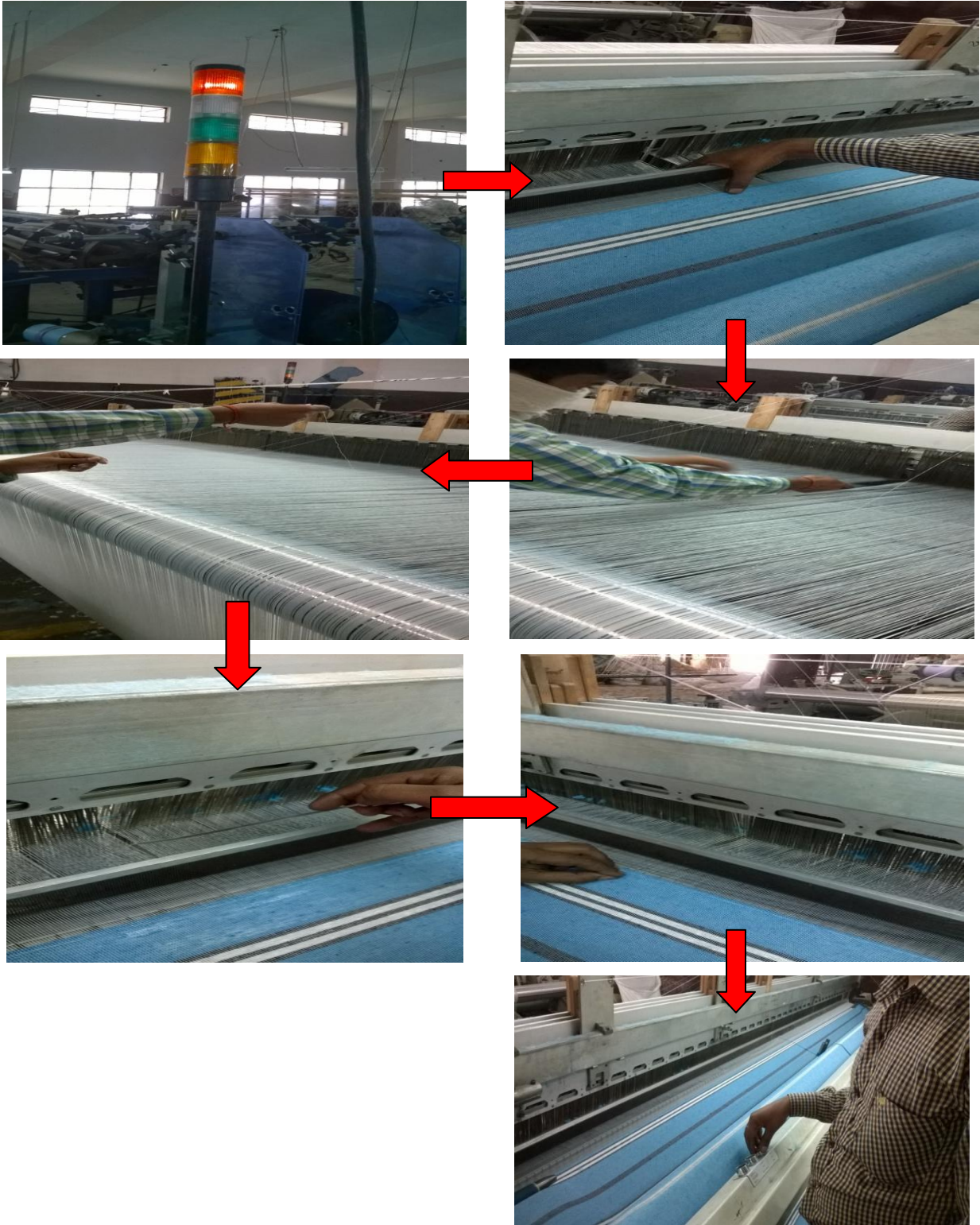

- to check the indicating lamp
- to find out the broken warp end
- find out the location of the broken end, by bringing the hands under the dropper bars , with mechanical droppers
- use electrical warp stop motion , to detect the location using the indication lamp and by bringing the hands over the droppers
- be able to mend the broken warp end in the sized beams with the thrums of the same count of the sized beams, using " weavers ' knots"
- be able to draw the mended warp yarn through the healds properly , as per the drawing order prescribed
- start the loom without inching/ in one stroke
- to check the indicator lamp
- find out the breakage place ( whether it is before accumulator or in the accumulator or in the weft feeder or in the Water jet )

➤ **Attending to Weft Break**

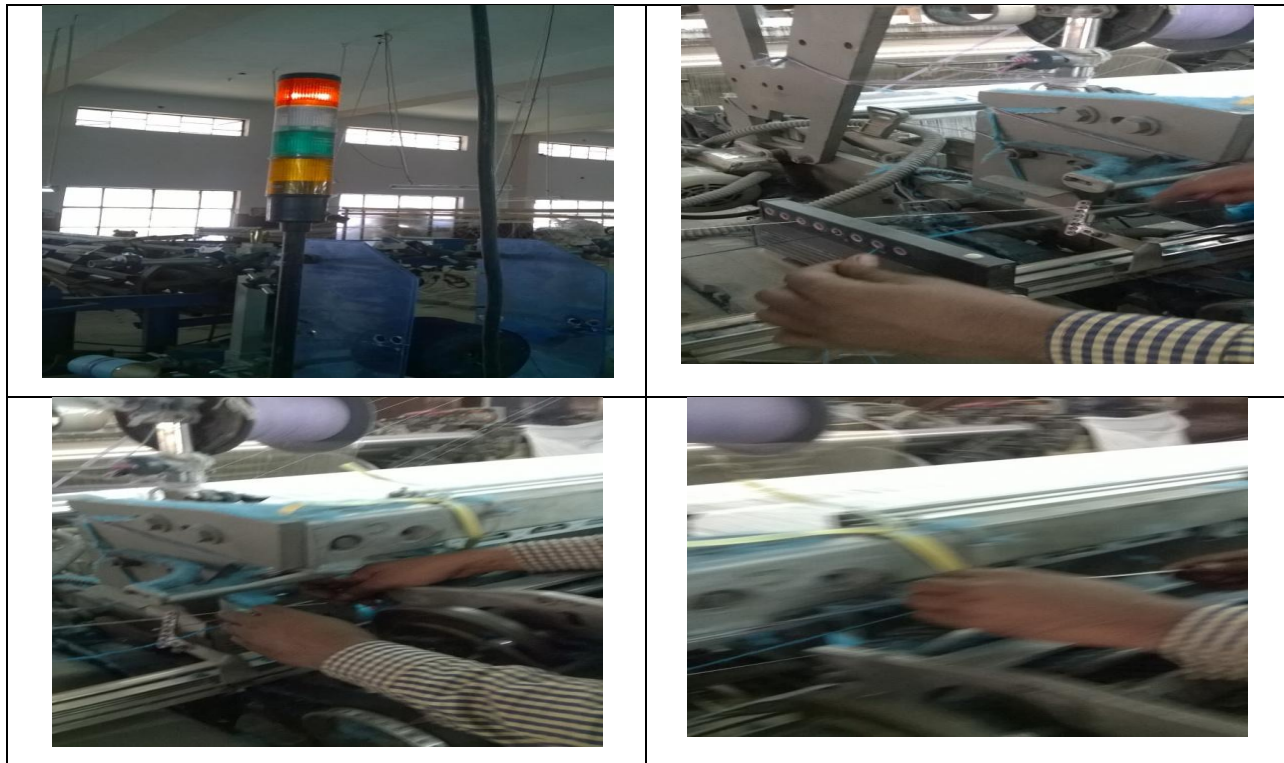





- to use weft wire if the weft is cut before accumulator or in the accumulator
- be able to find out the last pick inserted in the produced cloth, by ensuring proper pick finding
- Start the loom without inching/ in one stroke.

➤ **Other Work Practices**

- correct the fabric defects like wrong drawing, wrong denting , end out , double end etc., immediately and also ensure that the other fabric defects too are corrected at the earliest, before continuing further production
- clean the machines and work area, so as to ensure good working atmosphere, without damaging the fabrics in the looms where the cleaning work is carried out as well as in the adjacent & opposite looms. should not misuse " Water" . in case of any floats, should be able to " unweave " the same & should be able to run the machine without " starting mark or crack"
- after attending to the warp breaks, should ensure that the loose threads are hanged in higher length ( not more than 4 mm) . accordingly, it has to be trimmed
- to draw catch card ends properly
- to ensure the size of the catch card & the selvedge
- weft yarn reserve packages have to be tied with tail ends of the running weft yarn package & ensure proper transfer
- patrol the machines and do mending so as to minimise the stoppages

- Should tie the “waist bag” & all the waste generated by the weavers are collected in the said waist bag, which can be ultimately disposed in the places/ bins provided, at the end of the shift.
- ensure that the correct weft yarn, as per the "loom card" only is used
- see that the weft yarn is completely used , without giving room for additional wastage of raw materials. for any quality issue or defective cone etc., the same has to be brought to the notice of the superiors
- not pull out warp ends or catch card ends, unnecessarily. if end is getting cut often in the selvedge or in the catch card, , the same has to be brought to the notice of the mechanics/ fitters/ superiors & get it corrected
- ensure that all the stop motions, indication lamps , preventive mechanisms etc., function properly
- ensure correct quality of thrums are there & see that the same are properly tied
- check the knotted loom for knotting quality etc. double ends have to be removed
- report to superiors for any deviation in the same & for any other quality issue
- ensure that his/ her looms are stopped for a minimum possible down time due to whatever reason & see that he/ she gets maximum outputs in his/ her shift
- check the fabrics for the defects at least twice in a shift and sign on the cloth in both times
- ensure that cloth rolls are doffed whenever/ wherever necessary
- give preference to safety.
- not enter the area, where he/ she is not allowed.
- not do a job in which training has not being given
- ensure that no raw material/ cloth/ spare/ tool / any other material is thrown under/ near the machines or in the other work areas.
- check for the reasons for the frequent warp/ weft breaks . The reasons that could be corrected by him/ herself should be corrected. Otherwise, the same has to be reported to the mechanics/ fitters/ superiors.