

## TABLE OF CONTENTS

<b>Part No.</b>	<b>Contents</b>	<b>Page No.</b>
<b>1</b>	<b>Basics</b>	<b>1</b>
	<b>1.1 Basic Textile Terms of Spinning</b>	<b>2</b>
	<b>1.2 Sequence of spinning process</b>	<b>3</b>
	<b>1.3 Material Flow in Spinning</b>	<b>4</b>
<b>2</b>	<b>Draw Frame</b>	<b>7</b>
	<b>2.1 Functions of Draw Frame</b>	<b>8</b>
	<b>2.2 Details of Draw Frame</b>	<b>8</b>
	<b>2.3 Operating Draw Frame</b>	<b>12</b>
<b>3</b>	<b>Lap Former</b>	<b>16</b>
	<b>3.1 Functions of Lap Forming Machine</b>	<b>17</b>
	<b>3.2 Details of Lap Forming Machine</b>	<b>17</b>
	<b>3.3 Operating Lap Forming machine</b>	<b>19</b>
<b>4</b>	<b>Comber</b>	<b>23</b>
	<b>4.1 Functions of Comber Machine</b>	<b>24</b>
	<b>4.2 Details of Comber Machine</b>	<b>24</b>
	<b>4.3 Operating Comber machine</b>	<b>28</b>
<b>5</b>	<b>General Responsibilities</b>	<b>31</b>
	<b>5.1 Responsibilities during shift change</b>	<b>32</b>
	<b>5.2 Importance of Health &amp; Safety</b>	<b>34</b>

# Part-1

# Basics

## 1.1 Basic Textile Terms of Spinning:

**Fiber:** The fundamental component used in making textile yarns and fabrics. Fibers are fine substances with a high ratio of length to thickness. They can be either natural (e.g. cotton, wool, silk etc.) or synthetic (e.g. polyester, nylon, acrylic etc.).

**Blow room Lap:** The Loose strand, roughly parallel, untwisted fiber sheet produced in blow room.

**Chute feed system:** It is a system of feeding small tufts of fibers directly from blow room to a series of cards, arranged in a circuit through pneumatic pipe.

**Sliver:** The strand of loose, roughly parallel, untwisted fibers produced in Carding.

**Roving:** The soft strand of carded/combed fibres that has been twisted, attenuated, and freed of foreign matter, which is a feed material to spinning.

**Yarn:** A continuous strand of textile fibers that may be composed of endless filaments or shorter fibers twisted or otherwise held together.

**Spinning:** The process of making yarns from the textile fiber is called spinning. Spinning is the twisting together of drawn out strands of fibers to form yarn.

### Yarn Count/Sliver Hank

Yarn count is the numerical expression of yarn, which defines its fineness or coarseness. (Linear density).

Yarn count system:

Indirect system: English count (Ne), Worsted Count etc.

i.e. Higher the yarn number, finer the yarn.

Direct System: Tex, Denier

i.e. Higher the yarn number, Coarser the yarn.

Similarly numerical expression of fineness or coarseness of Lap, sliver & roving are called Hank.

Note: English (Ne) count system is commonly followed in India.

English Count: No. of Hanks of length 840 yds weighing in 1 pound

1yds: 0.9144mtrs

1lbs: 0.453 Kgs.

e.g.  $40^S$  Ne = 40 hanks of 840 yds weighs 1 lbs.

$20^S$  Ne = 20 hanks of 840 yds weighs 1 lbs.

## 1.2 Sequence of Spinning Process:

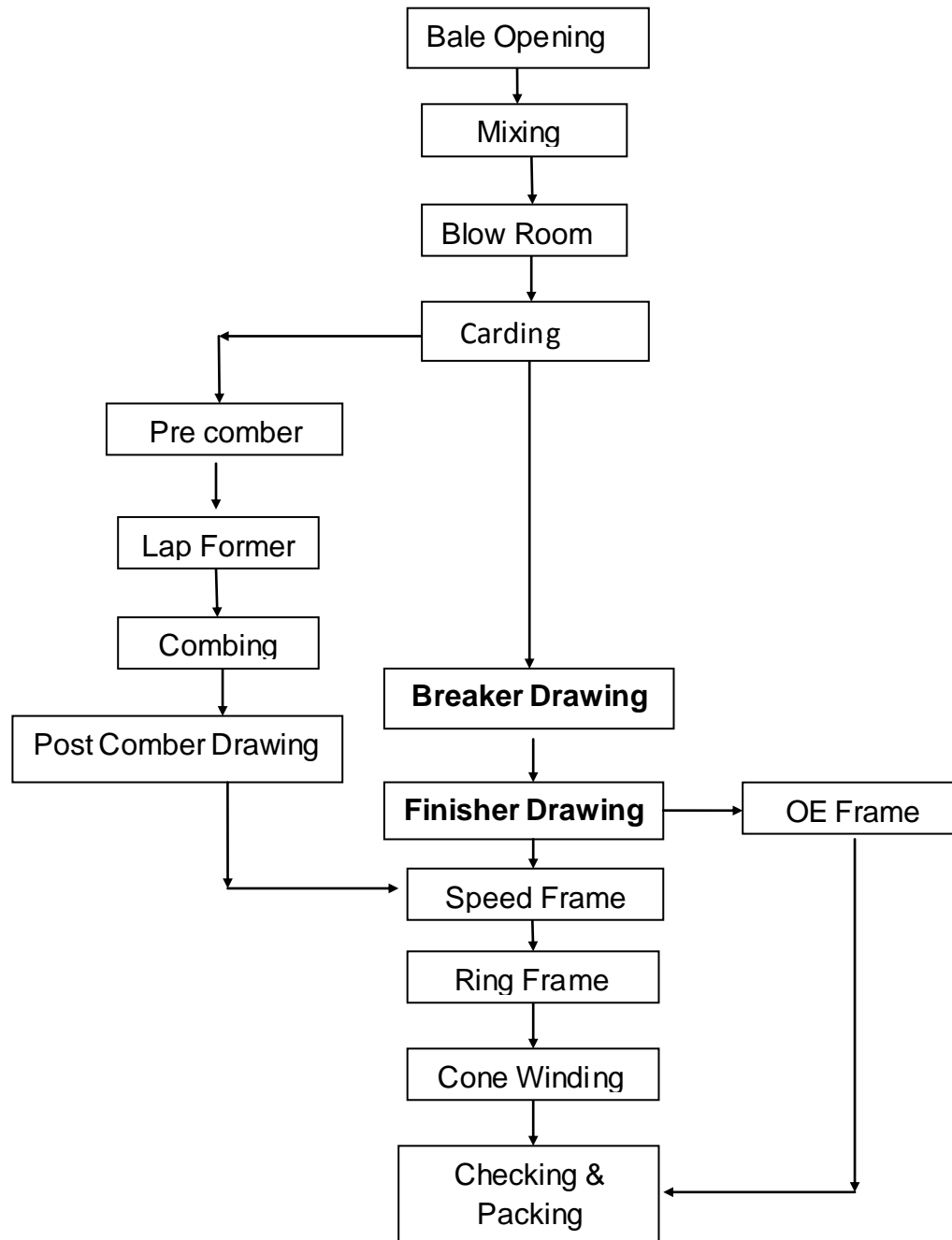

### 1.3 Material Flow in Spinning:

#### Carded Yarn Manufacturing:

TABLE-1

STAGE	MACHINE	INPUT MATERIAL	OUT PUT MATERIAL	PACKAGE FORM
Opening & cleaning	Blow Room machines	Raw cotton	Lap or chute feed	-
Carding	Card	Lap or chute feed	Card sliver	Slivers in Can
<b>1<sup>st</sup> drawing</b>	<b>Breaker Draw frame</b>	<b>Card sliver</b>	<b>Drawn sliver</b>	<b>Sliver can</b>
<b>2<sup>nd</sup> drawing</b>	<b>Finisher Draw frame</b>	<b>Drawn sliver</b>	<b>Drawn sliver</b>	<b>Sliver in can for Roving</b>
Roving	Speed Frame	Drawn sliver	Roving	Roving bobbin
Spinning	Ring spinning frame	Roving	Ring-spun yarn	Spinning Cops
Post-Spinning processes	Winding & Reeling	Yarn in spinning cops	Yarn	Cone, Cheese & Hank

#### Combed Yarn Manufacturing

TABLE-2

STAGE	MACHINE	INPUT MATERIAL	OUT PUT MATERIAL	PACKAGE FORM
Opening & cleaning	Blow Room machines	Raw cotton	Lap or chute feed	-
Carding	Carding machine	Lap or chute feed	Card sliver	Carded Slivers in Cans
<b>Pre comber Drawing</b>	<b>Breaker Draw Frame</b>	<b>Carded Sliver</b>	<b>Drawn Sliver</b>	<b>Drawn slivers in cans</b>
<b>Lap Formation</b>	<b>Super Lap or Lap Former</b>	<b>Drawn Slivers</b>	<b>Lap</b>	<b>Laps in spools</b>
<b>Combing</b>	<b>Comber</b>	<b>Lap</b>	<b>Combed Sliver</b>	<b>Combed sliver in Cans</b>
Post comber Drawing	Finisher Draw Frame	Combed sliver	Drawn sliver	Post comber Draw frame slivers in cans
Roving	Speed Frame	Post comber Draw frame sliver	Roving	Roving bobbin
Spinning	Ring spinning frame	Roving	Ring-spun yarn	Spinning Cops
Post-Spinning processes	Winding & Reeling	Yarn in spinning cops	Yarn	Cone, Cheese & Hank

**Open End Yarn Manufacturing:**

**TABLE-3**

<b>STAGE</b>	<b>MACHINE</b>	<b>INPUT MATERIAL</b>	<b>OUT PUT MATERIAL</b>	<b>PACKAGE FORM</b>
Opening & cleaning	Blow Room machines	Raw cotton	Lap or chute feed	-
Carding	Card	Lap or chute feed	Card sliver	Slivers in Can
<b>Drawing</b>	<b>Draw frame</b>	<b>Card sliver</b>	<b>Drawn sliver</b>	<b>Sliver can</b>
OE Spinning	OE Frame	Drawn sliver	OE yarn	Cheese

**Various Package Form:**

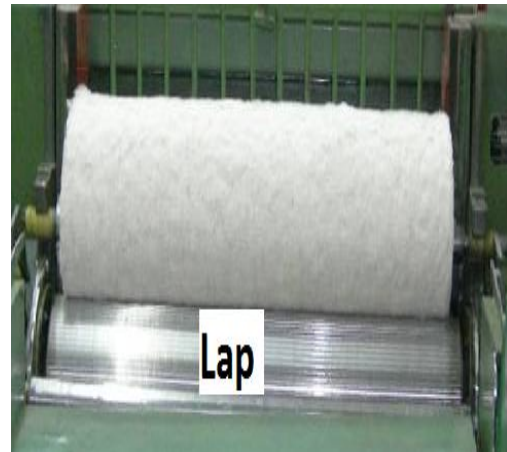



**Roving Bobbin**



**Ring Bobbins**



**Cone Packages**



**Cheese Package**

# Part-2

## Draw Frame



## 2.1 Functions of Draw Frame Machine:

- To straighten the curled and hooked fibres.
- To make the fibres parallel to their neighbouring fibres.
- To improve uniformity of fibres by drafting and doubling.
- To reduce weight per unit length of sliver.
- To remove micro dust from slivers by air suction pipe.
- To blend raw material of same hanks perfectly.

## 2.2 Details of Draw Frame Machine:

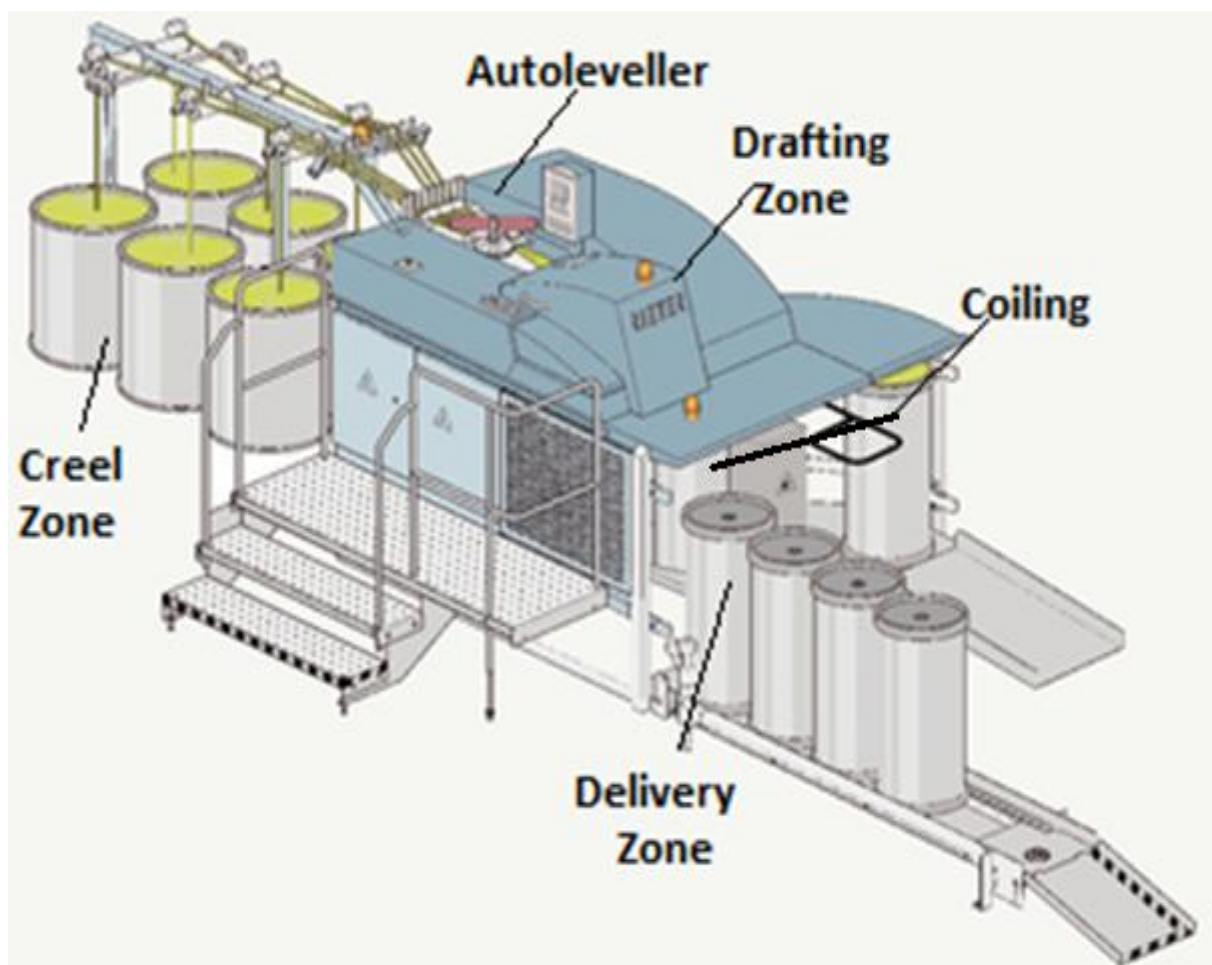

## Type of Draw Frame:

**Breaker Draw frame:** Feed material is carded sliver. During this process 6-8 carded slivers are fed to this machine to produce more parallelized breaker sliver.



**Finisher Draw frame:** Feed material is breaker draw frame drawn sliver. During this process 6-8 breaker slivers are fed to this machine to produce more parallelized & uniformed finisher sliver.



## Different Zones of Draw Frame Machine:

### Creeling zone:

It is known as feeding zone. 6-8 feed slivers passing through guide roller, guide bars & feed to drafting zone.



### Guide Roller :

It guides the passage of feed slivers and act as a stop motion when feed sliver breaks



### Auto leveller:

The main task of auto levelling is to eliminate deviations in mass per unit length



### Drafting zone:

It is the zone for a process of decreasing the weight per unit length of sliver. It is mainly due to differential peripheral speed of the rollers.

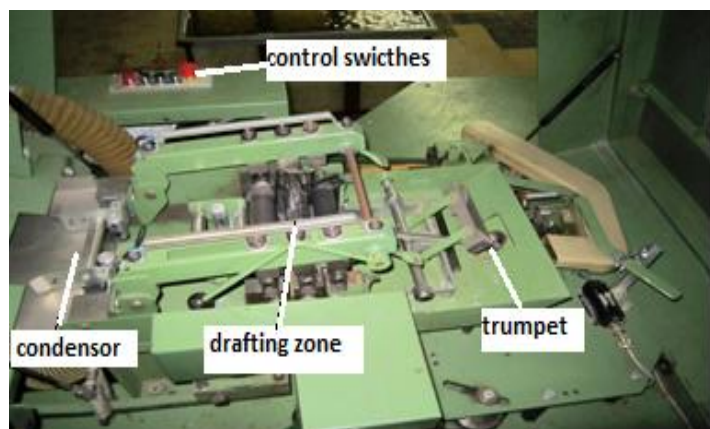

**Sliver Coiling:**

The rotary movements are required for cycloidal coiling of the sliver. On the one hand, the rotatable plate must be rotated above the can, while the can itself must rotate, at a considerably slower rate, below the plate. A sliver tube is provided on the plate as a fixed part to guide the sliver from the calendar rollers into the can.



**Doffing of cans:**

In Single-step changers full cans are replaced by empty ones at full speed, i.e. without stopping the machine.

In Multiple-step changers machine is brought to a stop during the change.



**Signal Lamps:**

Signal lamps are provided on the machine to indicate the reason for stoppage of machine. Understand each signal lamp and their purpose in the machine.





## Display Panel:

It displays various operating machine parameters like speed, production etc. Understand the details in the display panel and work accordingly



### 4.3 Operating Draw Frame Machine:

- Creel the required number of cans and draw the slivers forward.
- Take the slivers through all guide rollers and feed to drafting zone.
- Operate the control switches for inching, starting and stopping the draw frame.
- By inching feed the material and start running.
- Follow the different signal lamps & stop motions used in machines.
- Piece the sliver during breakage & Doff the full sliver cans.
- View the display panel and identify the reasons for machine stoppages if any.
- Inform the supervisor and maintenance in charge in case of a jam and in case of any break-downs support to carry out maintenance activities.
- Carryout cleaning activities in creeling, drafting, and delivery zones.
- Remove the suction waste periodically & segregate the wastes collected and put them in the designated bins.
- Always keep Draw frame area clean.

#### ➤ Importance of Colour coding:

The details related to colour coding like card sliver can, draw frame sliver can and other relevant information like Hank of sliver etc, are normally displayed in respective machine's display board. It is the responsibility of the machine operator to understand them & work accordingly.

#### Identifying Defects:

- Defects in sliver like, uneven sliver, neps in slivers, slivers with high variation etc., are to be identified and informed to supervisor for necessary action.

**Attending the Machine on Sliver Break:**

- Identify the machine stoppage for sliver breaks by viewing the signal lamps and display panel.
- Identify the broken sliver; piece the sliver/s as per standard piecing procedure.
- Open the calendaring zone
- Collect and condense through the calendaring rollers and trumpet for sliver formation.
- Draw the sliver through the conveyer rollers and pass it through the coiler rollers in delivery zone into the sliver can.
- Ensure proper functioning of machine after piecing.
- Collect the wastes generated during piecing and keep it at respective waste box.





Attending sliver break at Drafting zone



Piecing of sliver to pass through trumpet

#### Activities at Drafting Zone:

- Interchange top rollers in drafting zone as per the schedule displayed on the machine.
- Attend to roller lapping and chocking of sliver. If lapping occurs remove the roller lapping manually without damaging the cots and ensure minimum waste. If lapping occurs frequently report to the supervisor immediately.



- Release the pressure on top rollers when the machine is to be stopped for longer duration.
- Clean the drafting zone periodically
- Inform the supervisor and maintenance in charge in case of a jam.



### **Carrying out Can Doffing:**

- Clean the can castors before feeding.
- Keep the required number of specified colour coded empty cans near doff zone for automatic can change.
- Keep the empty sliver can near the doffing machine in manual doffing.
- Doff the full sliver can in case of manual doffing.
- After doffing ensure that the can is seated properly and sliver is delivered continuously in the can

### **Cleaning the Draw Frame & Waste disposal**

- Carry out cleaning of Draw frame as follows or as instructed by supervisor
- Always safely carry out cleaning activities
- Carryout cleaning activities in creeling zone, drafting zone, and in Coiler using suitable equipment like brush.
- Periodically remove the dust from creeling area.
- Remove the soft waste piled up if any from creeling, drafting and delivery zone.
- Clean the doors and covers of the machine at periodical intervals and keep them free from fluff accumulation.
- Check the wastes collected from different parts of machine are deposited in the respective bins
- Keep the Draw Frame department clean.



# Part-3

## Lap Former



### 3.1 Functions of Lap Forming Machine:

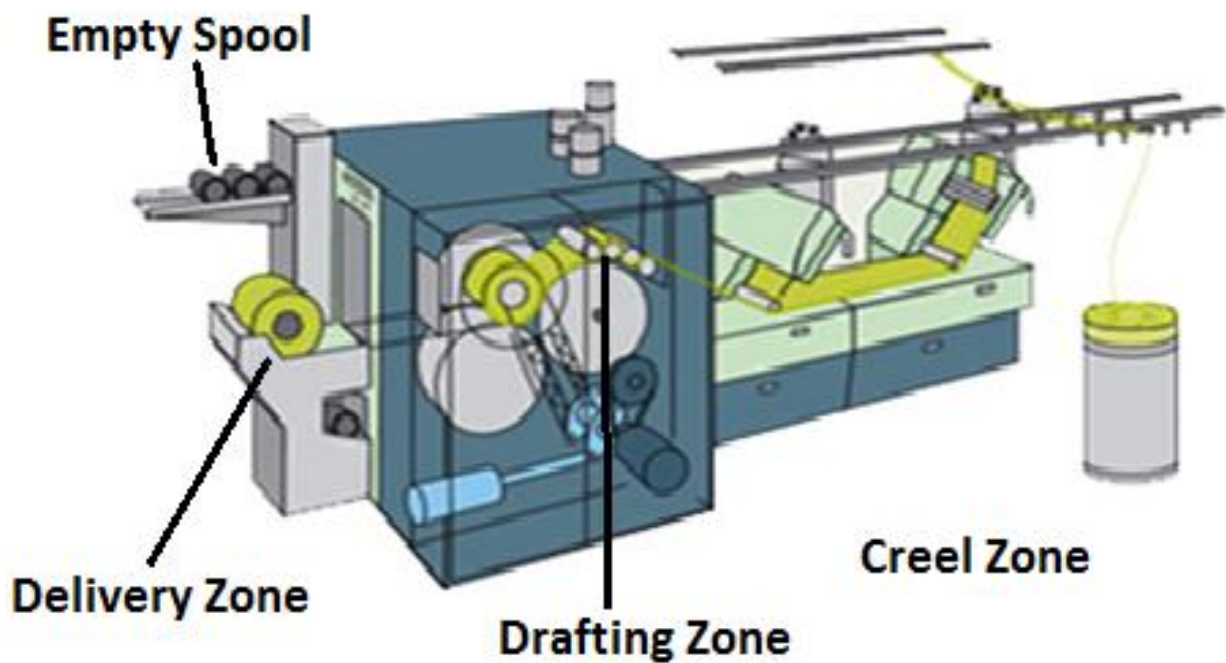

- Doubling certain number of Draw frame slivers (from 16 to 32).
- Imparting slight draft to the material fed.
- Calendar the material to form lap.
- Winding the lap on Spools
- Doffing out the fully wound Lap

### 3.2 Details of Lap Forming Machine:



## Operations of Lap former Machine:

<p><b>Creeling zone:</b></p> <p>It is known as feeding zone. 16 to 32 Draw Frame slivers passes through guide roller, guide bars &amp; fed to drafting zone.</p>	
<p><b>Guide Roller :</b></p> <p>It guides the passage of feeding slivers and act as a stop motion when feed sliver breaks</p>	
<p><b>Calendar rollers &amp; Lap formation :</b></p> <p>The slivers are fed side by side, passing, through rollers and stop motion. The slivers enter the drafting section and then calendar section to produce a compact lap. Finally the lap is wound on to Spool. In the lap former, the material undergoes a light slight draft</p>	

<p><b>Doffing of Lap:</b> The Lap former doffs automatically once the desired length of Lap is wound on the spools. During doffing empty spools are taken by the machine itself from the reserve holder and next round of winding starts.</p>	
<p><b>Signal Lamps:</b> Signal lamps are provided at the top of the machine as well as the creel side to indicate the reason for stoppage of machine. Understand the signal lamp and their purpose in the machine.</p>	
<p><b>Display Panel:</b> It displays machine speed, hank of Lap &amp; production in mtrs etc. Understand the details in the display panel and work accordingly.</p>	

### 3.3 Operating Lap Former Machine:



- Understand the mixings and the colour coding of Spool used from the display board and ensure the same with superiors.
- Ensure the correct hank of sliver and colour coded cans are taken for creeling.
- Creel the required number of Breaker Draw frame Sliver cans.
- Ensure proper creeling and maintain correct tension of slivers while creeling.
- Draw the slivers to the drafting zone through all guide rollers and stop motions.
- Operate the control switches for inching, starting and stopping the Lap Former
- By inching feed the material and start running.
- Follow the different signal lamps and stop motions used in machines.
- Piece the sliver during breakage.
- Remove the doffed laps from machine and keep in trolley.
- Send the Laps Trolley to comber machine.

- Keep the empty spools received from Comber in the reserve Spool holder.
- View the display panel and identify the reasons for machine stoppages if any.
- Inform the supervisor and maintenance in charge in case of any break-downs
- Carryout cleaning activities in creeling, reserve Holder, drafting zones, and Lap doffing zones as per the instructions of superiors by adhering the safety norms .
- Remove the suction waste periodically & segregate the wastes collected and put them in designated bins.
- Always keep Lap Former machine area clean.

**Importance of Colour coding:**

The details related to colour coding like draw frame sliver can colour, spool colour and other relevant information like Hank of sliver etc, are normally displayed in respective machine’s display board. It is the responsibility of the machine operator to understand them & work accordingly.

**Attending the Machine on Sliver Break:**

<ul style="list-style-type: none"> <li>➤ Identity the machine stoppage for sliver breaks/sliver exhaust by viewing the signal lamps</li> <li>➤ Check which and where the sliver is broken/exhausted, take minimum time to attend the sliver breakage</li> </ul>	
<ul style="list-style-type: none"> <li>➤ Piece the sliver between cans in the event of sliver exhaust in sliver can and replace with a full sliver can</li> <li>➤ Identify sliver breakages and piece the sliver during breakage. While piecing the</li> </ul>	



sliver do not do too soft or too hard piecing.

- Ensure proper functioning of machine after piecing.
- Ensure that the sheet of slivers passes without curls or unevenness
- Check sliver tension in the creeling section is appropriate.
- Collect the wastes generated in the hip bags and store the waste at respective waste box.
- Segregate the reusable wastes and transfer the reusable wastes of lap former to designated storage area.



### Activities at Doffing Zone:

- Fill the empty spools in the reserve holders.
- Attend to lapping or chocking. If it occurs stop the machine and remove lapping/chocking safely
- If lapping or chocking occurs frequently report to the supervisor immediately.

- **Lap Doffing:** Collect the correct colour coded empty Spools from comber machine for filling the Spools in the Spool Holder
- Ensure that the spools are clean & free from damages.
- If needed clean the Spools before keeping them in the Spool reserve holder for automatic doffing
- Keep the required number of correct colour coded spools in the reserve holder for automatic lap change
- Ensure whether the machine is ready for doffing by viewing the details in display panel
- Keep the lap trolley ready near the machine for doffing
- Ensure the laps are properly doffed and placed in the lap trolley
- Ensure proper functioning of lap former after doffing.



### **Cleaning the Lap Former & Waste disposal**

- Carry out cleaning of Lap Former as follows as periodically or as instructed by supervisor
- Always safely carry out cleaning activities
- Carryout cleaning activities in creeling zone, Web Passing place and delivery zone using suitable equipment like brush.
- Periodically remove the dust from creeling area.
- Remove the soft waste piled up if any from creeling and other machine area.
- Clean the doors, covers and the lap stand at periodical intervals and keep them free from fluff accumulation.
- Check the wastes collected are deposited in the respective bins
- Keep the Lap Former department clean.

**Part-4**

**Comber**



#### 4.1 Functions of Comber Machine Functions:

- To remove predetermined quantity of short fibres.
- To remove the remaining impurities.
- To remove neps in the fibre material.
- To form the sliver having maximum possible fibre parallelisation.

#### 4.2 Details of Comber Machine:

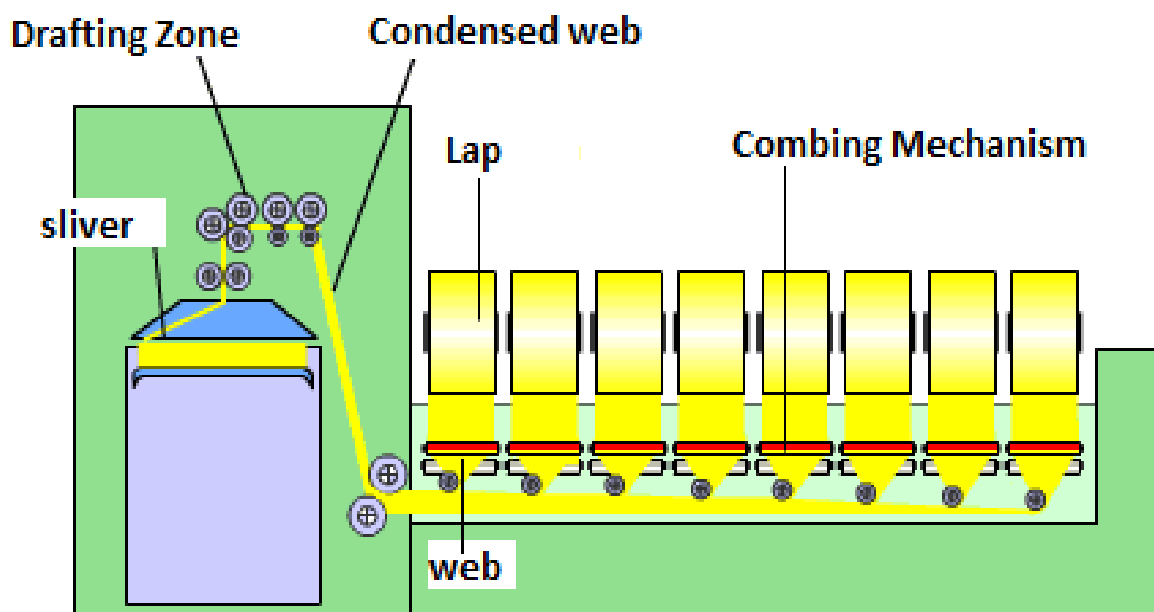



**The major zones of comber machine:**

**Creel Zone:**

It is known as feeding zone. 08 comber laps passes through guide roller, guide bars and are fed to the combing zone.



**Combing Zone:**

The Feed rollers moves lap sheet forward and is gripped by the nippers.

The gripped lap is combed by circular comb.

The detaching roller grips the combed lap and moves forward.

When the detaching roller delivers the material, top comb comes into action to further clean the lap.

While going back, the nipper opens and receives a new bit of lap.

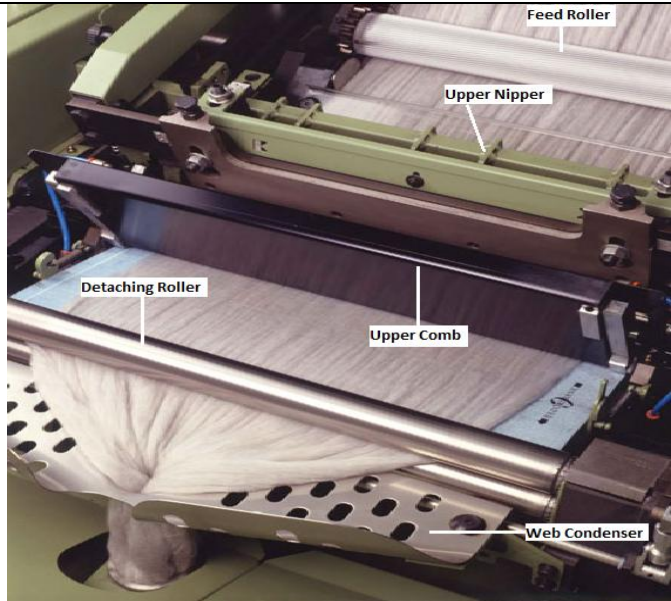

**Drafting Zone:**

It is the zone for a process of imparting slight draft. The drafting is due to differential peripheral speed of the rollers.



**Doffing:**

The comber doffs automatically once the desired length of sliver is filled in the can. During doffing empty sliver can are taken by the machine automatically or fed or manually.

**Display Panel:**

It displays machine speed, delivery hank & production in meters etc.

Understand the details in the display panel and work accordingly.

**Signal Lamps:**

Signal lamps are provided at the top of the machine as well as the creel side to indicate the reason for stoppage of machine. Understand the signal lamp and their purpose in the machine.



### 4.3 Operating Comber Machine:

- Creel the required number of Laps to machine.
- Take the Lap through guide rollers and feed to combing zone.
- Operate the control switches for inching, starting and stopping the comber machine.
- By inching feed the material and start running.
- Follow the different signal lamps & stop motions used in machines.
- If there is web breakage, Condense the web properly and feed through trumpet for the even passage of sliver and ensure that the sliver passes to drafting zone uniformly along with other slivers.
- Attend to any breakage in the condensing of slivers to drafting zone.
- Piece the slivers properly and avoid unevenness.
- Feed the empty can in case of manual doffing.
- Periodically remove noils as per instructions and store them at designated place.
- View the display panel and identify the reasons for machine stoppages if any.
- Inform the supervisor and maintenance in charge in case of any break-downs and support for carrying out maintenance activities.

#### **Importance of Colour coding:**

The details related to colour coding like lap spool colour, sliver can colour, and other relevant information like Hank of sliver etc, are normally displayed in respective machine's display board. It is the responsibility of the machine operator to understand them & work accordingly.

#### **Identifying Defects:**

- Defects in comber web like thick and thin bar in comber web, etc. are to be identified and informed to supervisor for necessary action.
- Defects in combed sliver like higher comber sliver variations etc are to be identified and informed to supervisor for necessary action.
- Defects in process like Lap running slackly, difference in Noil between heads, poor nep removal efficiency etc., are to be informed to supervisor for necessary action.



### Attending to Lap running out / web breakage:

- Identity the machine stoppage for lap running out or web breakage by viewing the signal lamps.
- Check which Lap is running out or the web is broken and take minimum time for attending the breakage.
- Condense the web properly and feed through trumpet for the even passage of sliver.



**Attending web breakage in comber**



**Guiding the sliver after piecing**

### Carrying out Can Doffing:

- Clean the can castors before feeding.
- Keep the required number of specified colour coded empty cans near doff zone for automatic can change.
- Keep the empty sliver can near the doffing machine in manual doffing.
- Doff the full sliver can in case of manual doffing.



Doffing full Can from comber

### **Cleaning the comber & Waste disposal:**

- Carryout cleaning activities in creeling, combing, drafting, coiling areas.
- Clean the guide rollers; feed rollers, web condenser plate.
- Clean the combing roller, Nippers, Top comb and detaching roller etc with suitable equipment in a safe manner.
- Remove the waste while attending breakage and put them in appropriate waste collection bins.
- Always keep Comber machine area clean.

# Part-5

# General Responsibilities



## 5.1 Responsibilities during Shift Change

### Take Charge of the Shift

#### General

- Come at least 10 - 15 minutes earlier to the work spot.
- Meet the previous shift operator and discuss regarding the issues faced by them with respect to the quality or production or spare or safety or any other specific instruction etc.
- Check the cleanliness of the machines & other work areas.
- Check whether any spare/raw material/ tool / any other material are thrown under the machines or in the other work areas.
- Check the wastes collection boxes are empty while taking charge of shift.
- Check the work spot is clean.

#### In Draw Frame

- Understand the count/Hank produced, colour of card slivers cans & colour of Draw frame slivers cans followed in the Draw Frame for the allocated number of machines.
- Check and understand the technical details mentioned in the display board.
- Check for the availability of the feeding sliver cans for creeling.
- Check the sliver passage and proper formation of drawn sliver.
- Check the condition of all the running sliver cans.

#### In Lap Former

- Ensure to collect the details regarding mixing followed, Sliver Hank and colour of sliver cans as well as empty spool colour in the machines allotted.
- Check and understand the technical details mentioned in the display board.
- Check the sliver passage and proper formation of lap sheet.
- Check for the availability of the feeding sliver cans for creeling.
- Check the condition of all the running sliver cans.
- Check proper functioning of lap former machine parts and variations, if any report it to the supervisor.

### **In Comber machine**

- Understand the count produced, colour coding followed in the comber for the allocated number of machines.
- Check and understand the technical details mentioned in the display board.
- Check for the availability of the lap for creeling.
- Check for the availability of correct colour coded empty cans for sliver.
- Check the lap passage and proper formation of combed sliver.
- Check the condition of the running sliver cans.

### **Handing over the Shift:**

- Properly hand over the shift to the incoming shift operator.
- **In case of Draw Frame:** Provide the details regarding count/Hank produced, colour of card slivers cans & colour of Draw frame slivers cans followed in the Draw Frame for the allocated number of machines.
- **In case of Lap former:** Provide the details regarding count produced, colour coding followed for the sliver cans and the empty spools of comber Lap for the allocated number of machines.
- **In case of Comber:** Provide the details regarding count produced, colour coding followed in the comber for the allocated number of machines.
- Provide all relevant information regarding the, idle machines, damaged machine parts etc.,
- Collect the wastes from waste collection bags, weigh them and transport to storage area
- Complete the entry of waste collected category wise in the register
- Check whether the work place is clean.
- Get clearance from the incoming counterpart before leaving the work spot, in case if the next shift operators do not come, report to shift supervisor.
- Report to the shift supervisor about the quality / production / safety issues/ any other issue faced in the shift and leave the department only after getting concurrence for the same from supervisor.

## 5.2 Importance of Health & Safety

- Follow the safety work instructions or practices like not opening the doors of the machine, not cleaning the interior parts & not taking any choked material when the machine is in running condition.
- Always use head cap and face mask in the work spot.
- Do not carry any metallic parts during machine running as there are chances of fire and damage to machine parts.
- Take action based on instructions in the event of fire, emergencies or accidents, participate in mock drills/ evacuation procedures organized at the workplace as per organization procedures.