

TABLE OF CONTENTS

Contents	Page No.
➤ Basic Textile Terms of Spinning	1
➤ Sequence of Spinning process	2
➤ Material Flow in Spinning	3
➤ Functions of Cone Winding Machine	5
➤ Details of Cone Winding Machine	6
➤ Operating Cone Winding Machine	10
➤ Instructions for Shift Change	16
➤ Importance of Health & Safety	17

1. Basic Textile Terms of Spinning:

Fiber: The fundamental component used in making textile yarns and fabrics. Fibers are fine substances with a high ratio of length to thickness. They can be either natural (e.g. cotton, wool, silk etc.) or synthetic (e.g. polyester, nylon, acrylic etc.).

Blow room Lap: Finished product of blow room in the form of a sheet of fibers.

Chute feed system: It is a system of feeding small tufts of fibers directly from blow room to a series of cards, arranged in a circuit through pneumatic pipe.

Sliver: The strand of loose, roughly parallel, untwisted fibers produced in Carding, Draw frame.

Roving: A product of speed frame in the form of a soft strand of fiber that has been twisted, attenuated, and free from foreign matter preparatory to spinning.

Yarn: A continuous strand of textile fibers that may be composed of endless filaments or shorter fibers twisted or otherwise held together.

Spinning: The process of making yarns from the textile fiber is called spinning. Spinning is the twisting together of drawn out strands of fibers to form yarn.

Yarn Count/Sliver Hank

Yarn count is the numerical expression of yarn, which defines its fineness or coarseness. (Linear density)

Yarn count system:

Indirect system: English count (Ne), Worsted Count etc.

i.e. Higher the yarn number, Finer the yarn.

Direct System: Tex, Denier.

i.e. Higher the yarn number, Coarser the yarn.

Similarly numerical expression of fineness or coarseness of sliver & roving are called Hank.

Note: English (Ne) count system is commonly followed in India.

English Count: No. of Hanks of length 840 yds weighing in 1 pound

1yds: 0.9144 mtrs.

1lbs: 0.453 Kgs.

e.g. 40^s Ne = 40 hanks of 840 yds weighs 1 lbs.

20^s Ne = 20 hanks of 840 yds weighs 1 lbs.

Page No 1	RSA DOCUMENT
	Version No.01

2. Sequence of Spinning Process:

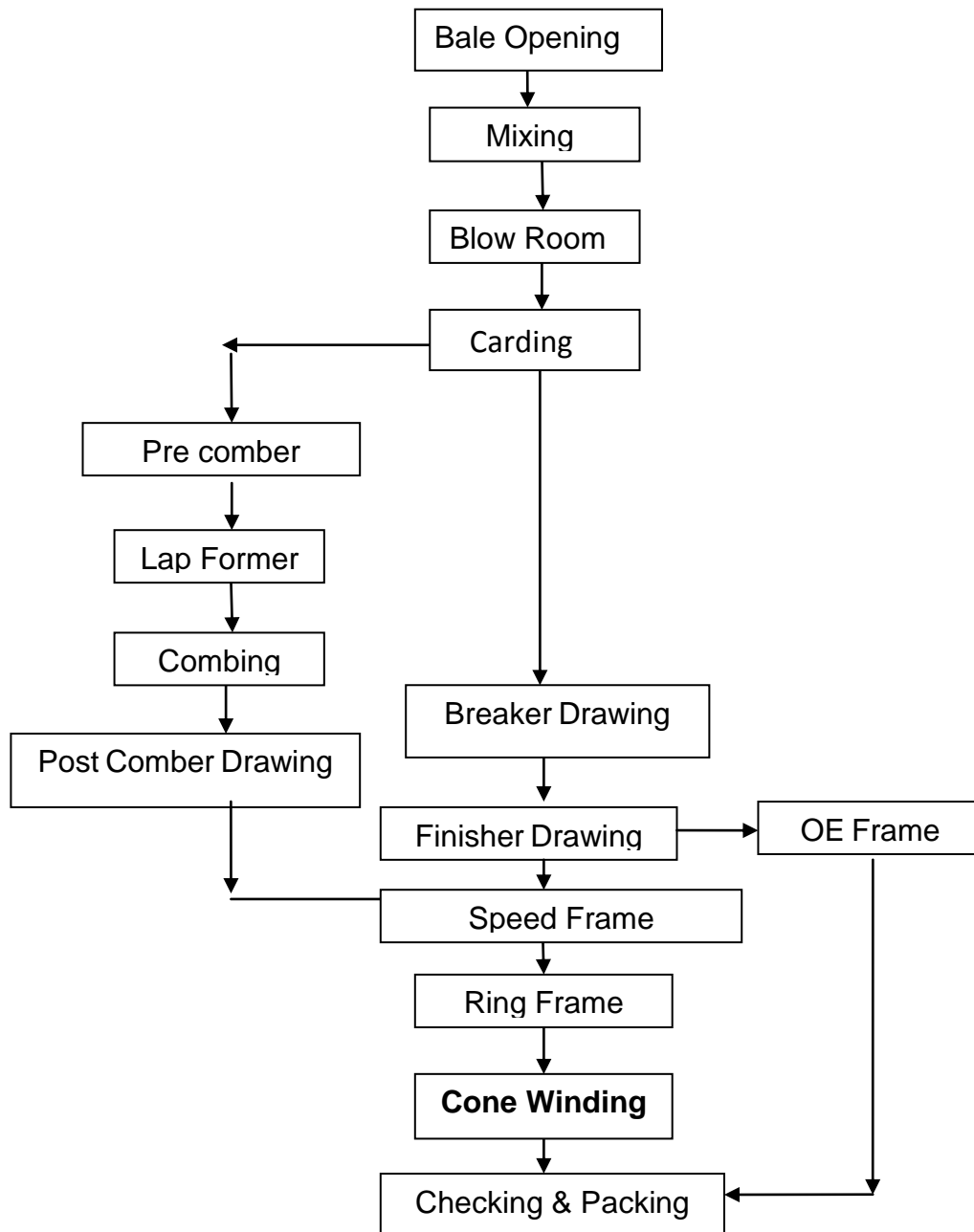

3. Material Flow in Spinning:

Carded Yarn Manufacturing

TABLE-1

STAGE	MACHINE	INPUT MATERIAL	OUT PUT MATERIAL	PACKAGE FORM
Opening & cleaning	Blow Room machines	Raw cotton	Lap or chute feed	-
Carding	Card	Lap or chute feed	Card sliver	Slivers in Can
1 st drawing	Breaker Draw frame	Card sliver	Drawn sliver	Sliver can
2 nd drawing	Finisher Draw frame	Drawn sliver	Drawn sliver	Sliver can for Roving
Roving	Speed Frame	Drawn sliver	Roving	Roving bobbin
Spinning	Ring spinning frame	Roving	Ring-spun yarn	Spinning Cops
Post-Spinning processes	Winding	Yarn in spinning cops	Yarn on cones	Yarn on Cones

Combed Yarn Manufacturing

TABLE-2

STAGE	MACHINE	INPUT MATERIAL	OUT PUT MATERIAL	PACKAGE FORM
Opening & cleaning	Blow Room machines	Raw cotton	Lap or chute feed	-
Carding	Carding machine	Lap or chute feed	Card sliver	Carded Slivers in Cans
Pre comber Drawing	Breaker Draw Frame	Carded Sliver	Drawn Sliver	Drawn slivers in cans
Lap Formation	Super Lap or Lap Former	Drawn Slivers	Lap	Laps in spools
Combing	Comber	Lap	Combed Sliver	Combed sliver in Cans
Post comber Drawing	Finisher Draw Frame	Combed sliver	Drawn sliver	Post comber Draw frame slivers in cans
Roving	Speed Frame	Post comber Draw frame sliver	Roving	Roving bobbin
Spinning	Ring spinning frame	Roving	Ring-spun yarn	Spinning Cops
Post-Spinning processes	Winding	Yarn in spinning cops	Yarn on cones	Yarn on cones

Various Package Form:





4. Functions of Cone Winding Machine:

- To remove yarn faults.
- To improve the quality of yarn.
- To wax the yarn during winding process.
- To make bigger package from ring bobbin in order to get continuous length of yarn on cones for subsequent processes like doubling, warping, weaving, Knitting etc.

5. Details of Cone Winding Machine:

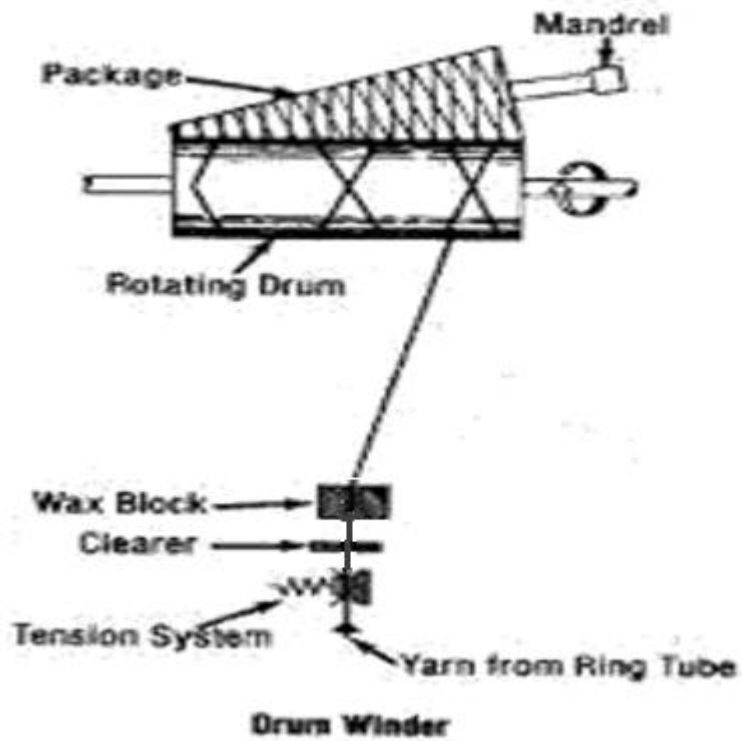

Main Parts of Cone Winding machine:

Creel to Hold Bobbins:

These are upright spindles mounted on Horizontal rods. The spindles have pins that hold the cop on the spindle. The Function of Bobbin Holder is to hold the filled bobbins for unwinding process.

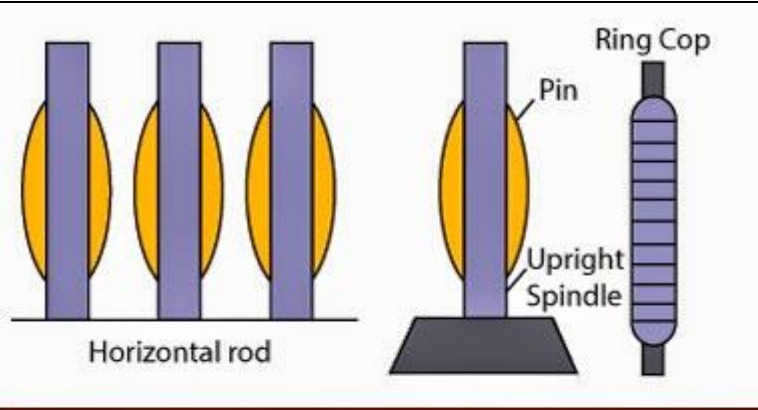
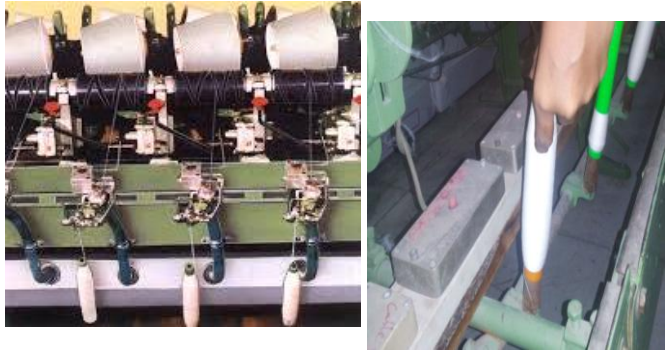
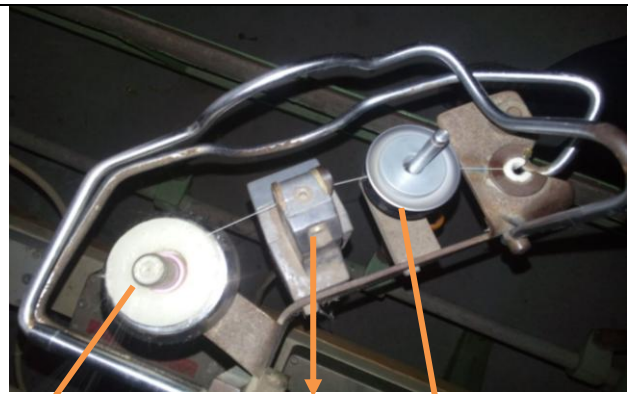

Fig: Creel for holding supply packages



Yarn tension weight, Clearer & waxing:

Yarn tension weight discs provide required tension to the yarn during unwinding from cop to winding on to cones for proper package formation. The clearer (EYC) will eliminate defects like thick place thin place etc. Wax disc below which the yarn passes applies wax to yarn and makes the surface of the yarn smooth by sticking hairy



Waxing roll
EYC clearer
Tension weight unit

fibres. Waxing is applied especially to the yarn intended for knitting.



Display of EYC settings

Cradle:

It's function is to hold the cone for winding. It lies on upper part of machine above the winding drum.

Winding drum:

It is a metallic drum and its surface is polished. It has grooves cut in to it, at its surface to help the cross winding of packages.

Cradle

Winding Drum



Empty cones

Knotter: Knotter is used to join two ends of broken threads to make continuous yarn.

Splicer: Broken threads are joined by untwisting and twisting the joining portion of threads called splicing to form knot free yarn.



Knotter

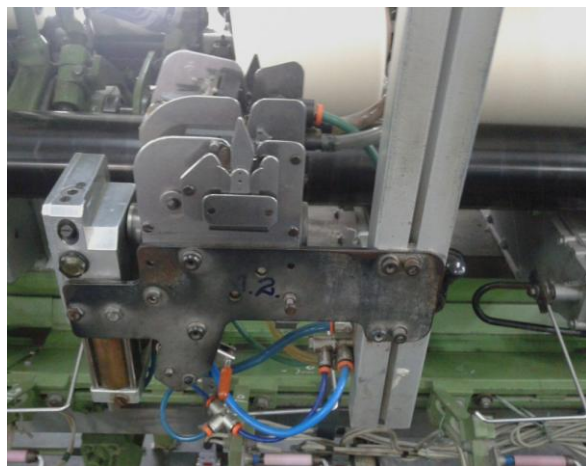

Splicer

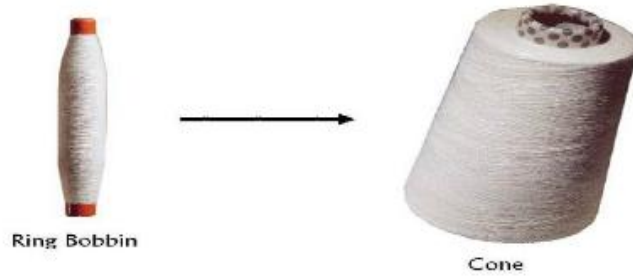

6. Operating Cone Winding Machine:

- Put the spinning cops (ring bobbins) of right colour code on the cop holder for all the drums
- Operate the control switches for starting and stopping the machine
- Follow the different signal lamps in machines.
- Ensure the Stop motion is functioning properly.
- Keep watching all the drums winding and identify the reasons for drum stoppages if any.
- Inform the supervisor in case of any machine break-downs.
- Always handle cones or cops with clean hands to avoid stain on the product.
- If lapping is there in any drum, remove the lapping manually with suitable equipment without damaging the drum.
- If there is ribboning in any cone, stop the cone and inform supervisor for correcting the defect.
- Ensure proper functioning of Ribbon Breaker.
- See that the tension weight mounted is as instructed by supervisor for the count running.
- Ensure that the Slub catcher (mechanical type) setting is as instructed.
- In case of EYC ensure it is switched on with right settings.
- Follow instructions /direction of supervisors, during count changes.
- If waxing is a requirement, put the waxes in the wax disc according to the material being processed as per the instruction of supervisor.
- Attend to yarn breakage by using the provided Knotter / Splicer
- Replace the new wax immediately if the wax disc runs out
- Check wax rolls running are clean and are freely rotating.
- Check the tension discs on the machines are clean and freely rotating.
- Once cone reaches required size, check its weight in the balance and if required weight is not reached, wind in the same drum for some more time and doff the full cones of correct weight.
- In case if excess weight is observed take it for rewinding to achieve correct weight.

Page No 10	RSA DOCUMENT
	Version No.01

- Ensure to record the Initial weight of cones during shift starting
- Record the no. of doffs and final weight of cones.
- Arrive at production in kgs at the end of the shift.
- Understand to work efficiently.
- Identify and report the different package defects to the supervisor.
- Transport empty cops to ring frame department.
- Carryout cleaning activities in the Creel, Tension weight, EYC or slub catcher, wax discs & winding drum and Cone holder.
- Remove the suction waste from Over Head Travelling Clearer (OHTC) periodically & segregate the wastes collected and put them in the designated bins.
- Always keep machine area clean.

Importance of Colour coding:

The details related to colour coding like Ring bobbin colour, empty cone tip colour and other relevant information like Count of yarn wound etc, are normally displayed in respective machine’s display board. It is the responsibility of the machine operator to understand them & work accordingly.

Identifying Defects:

- Defects in spinning cops like uneven cops, slough off, stained bunch of yarn etc., are to be identified and informed to supervisor for necessary action.
- Defects in cones like irregular shaped cones, soft or hard cones, stitches formation in cones and Ribbon formation etc are to be identified and informed to supervisor for necessary action.
- Defects such as yarn shade variation, twist variation, stains etc. are also to be identified and informed to supervisor for necessary action.

Creeling the cops

- Bring the correct colour coded cops in the cop trolley from storage area for creeling the winding machine
- Patrol around the winding machine and identify the cop exhaust.
- Fill the cops in the creel if it is running out
- Check and ensure the cop is properly placed in the cop holder

Page No 11	RSA DOCUMENT
	Version No.01

- Check the winding drums are not idle due to cops exhaust.
- Always take minimum time to creel the cops safely.

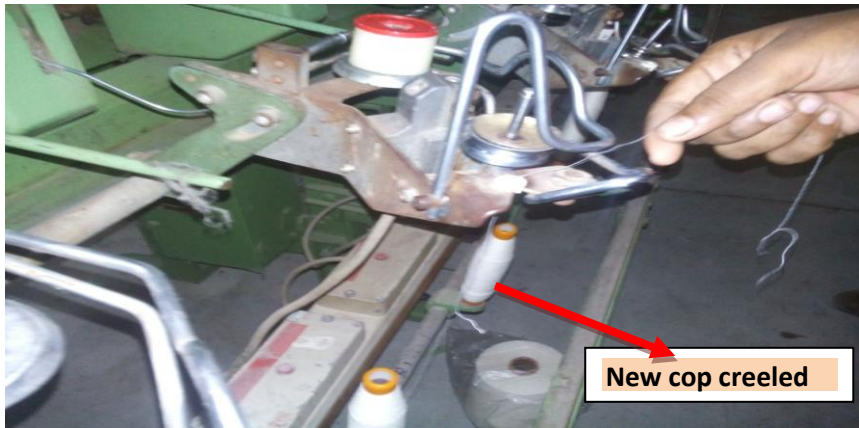

Attending to yarn breakage

- While attending to breaks or while replacing exhausted cops first lift the cone spindle from the surface of the drum to a certain height
- Properly stop the cone using left hand and take the yarn from the cone sideways by left hand without allowing the cone to rotate further.
- Take the yarn from spinning cop using right hand.
- Use the provided knotter or splicer for knotting/ splicing the broken yarn or during cop change
- Adopt proper procedure as instructed for operating the knotter / splicer.
- Knot the breakage with minimum loss of time and with minimum waste.
- Knot with minimum tails and trim the tails.
- After Knotting check knots for its good strength, small size and of minimum tail.
- If the Knotter / splicer is not working well get it repaired.
- Press down the cone holder lever and lay the cone spindle on the cone drum to continue winding
- Check whether the cone is properly laid on the winding drum and the yarn is properly being wound on the cone uniformly.

Page No 12	RSA DOCUMENT
	Version No.01

- Collect the hard waste while attending to breaks and put them in the hip bags or Apron pocket given.
- If abnormal vibrations occur after laying the cone on the winding drum, inform the supervisor.
- Always ensure safety while knotting/splicing the yarn

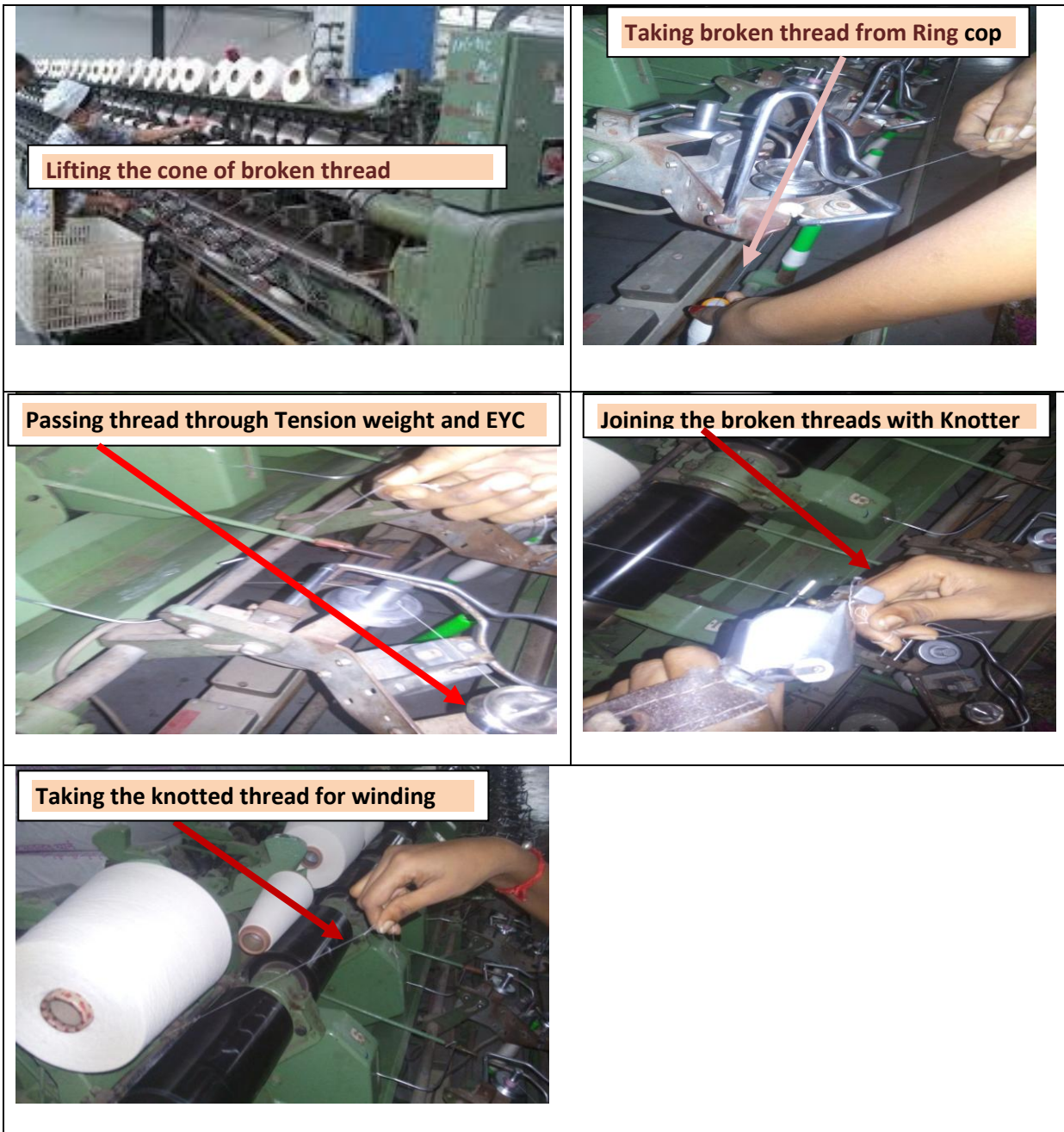

Doffing the cone package

- When the running cones become full ensure that they are wound till the required weight of yarn on cone package
- Check the cone package is fully wound to the predetermined weight and start doffing.
- If the required weight of cone is not achieved, fix the cone on the same cone holder and continue winding to achieve the required weight and then doff the cone.
- If excess weight is observed, take it for rewinding to reduce the cone weight to the desired level as instructed by supervisor.
- Follow the instructions of supervisor/Jobber to stop the machine for doffing or doff the cone package while the machine is running.
- Ensure that the cones doffed are wound up to the desired weight and are within tolerance limit in grams as instructed.
- Remove full cone package after achieving the required weight from cone holder and put them on peg trolley.
- If instructed, put the doffed cones in polythene cover before keeping the cones on the trolley.
- Now transport the trolley to the storage area as instructed.
- Keep the correct colour coded empty paper cone in the reserve area.
- Keep the hard waste removed during doffing in separate waste collection boxes.



Restarting winding after doffing

- Replace the doffed cones with correct colour coded empty cones with correct count label on cone holder after doffing.
- Before putting the empty cone on cone holder write inside the empty cone, the Drum No, Sider No. and shift details as instructed by supervisor.
- Put the tail end in the inside of the cone by taking the yarn through the cut mark provided at the bottom of the cone as specified before starting.
- Release the cone holder and ensure the paper cone is in surface contact with the winding drum and ensure proper traverse of yarn on winding drum.
- Ensure the proper passage of yarn in the winding machine for all drums.
- During count change do the necessary changes as per the instructions of the supervisor.



Cleaning of Cone Winding Machine & Waste disposal

- Clean the different mechanisms in the winding machine at the scheduled interval as instructed.
- Periodically clean the winding drum brush as instructed
- Ensure the waxing discs are clean.
- Keep the wastes in waste bags, piecer bags, or in aprons.

- Properly handle full cops, empty cops and full cones
- Clean the waste accumulation from different parts of the machine from time to time.
- Use proper tools for cleaning.
- Collect the hard wastes from waste collection box of OHTC in winding machine at regular intervals as instructed by supervisor
- Ensure OHTC is running continuously.
- The rejected cops in the empties trolley should be segregated, cleaned and returned.
- Clean all the half cops and damaged cops in the particular shift itself.
- Ensure safety while carrying out cleaning activities.
- Clean the wastes in the alley around the Winding Machine area.



7. Instructions for shift change

Taking Charge of the Shift

- Come atleast 10 - 15 minutes earlier to the work spot.
- Meet the previous shift operator and discuss regarding the issues faced by them with respect to the quality or production or spare or safety or any other specific instruction etc.
- Understand the count produced, colour coding followed in the Winding machine for his allocated number of drums or machines.
- Check the technical details are mentioned in the display board of the Cone Winding machine
- Check for the availability of the ring cops in trolleys.
- Check for the availability of the empty cones for the count running.

- Check all the winding drums are running properly, if any drum is idle enquire for the reason and report to the supervisor.
- Check the cleanliness of the machines & the work area.
- Check whether any spare/raw material/ tool / yarn / cops or any other material are thrown under the machines or in the other work areas.
- Check the Over Head Travelling Cleaner (OHTC) is working properly

Handing over the Shift:

- Properly hand over the shift to the incoming shift operator.
- Provide the details regarding count produced, colour coding followed in the Winding machine for his allocated number of drums or machines.
- Provide all relevant information regarding the count produced, idle drums, damaged machine parts if any.
- Collect the wastes from waste collection bags weigh them and transport to storage area.
- Ensure cleanliness of the work place.
- Get clearance from the incoming counterpart before leaving the work spot, in case if the next shift operators do not come, report it to shift supervisor.
- Report to the shift supervisor about the quality / production / safety issues/ any other issue faced in the shift and leave the department only after getting concurrence for the same from supervisor.

8. Importance of Health & Safety:

- Follow the work & safety instructions and adopt safe working practices like not opening the doors of the machine, not cleaning the interior parts & not taking any choked material when the machine is in running condition.
- Do not take the hands close to the winding drum while it is in working.
- Always use head cap, face mask and ear plug in the work spot.
- Do not carry any metallic parts during machine running as there are chances of fire and damage to machine parts.
- Take action based on instructions in the event of fire, emergencies or accidents, participate in mock drills/ evacuation procedures organized at the workplace as per organization procedures.

Page No 17	RSA DOCUMENT
	Version No.01